

# HIOKI

# POWER ANALYZER PW6001

## Improve Power Conversion Efficiency

From DC to 2MHz, industry's proven solution  
for high-accuracy power analysis.

The next-generation POWER ANALYZER.

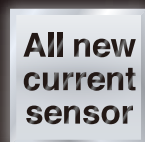

Newly Added  
Option



Newly Added  
Functions

# Achieving true power analysis

**DC, 0.1Hz to 2 MHz frequency bandwidth**

**Obtain even greater accuracy in high-frequency power measurements with the aid of Hioki's current sensor phase shift function**

A wide frequency range is required for power measurement due to the acceleration of switching devices, especially SiC. High accuracy, broadband, and high stability. The PW6001's world-class technology-based fundamental performance makes in-depth power analysis a reality.

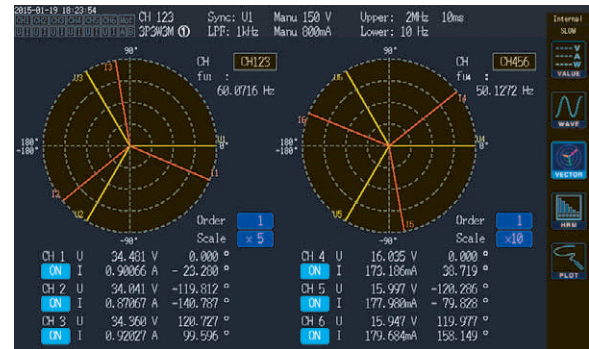
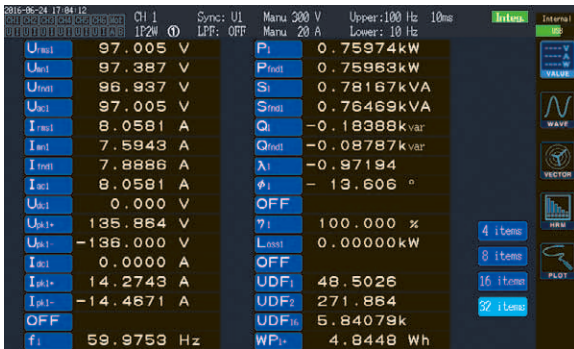

**±0.02%\* basic accuracy for power**

**Strengthened resistance to noise and temperature fluctuations in the absolute pursuit of measurement stability**

The custom-shaped solid shield made completely of finely finished metal and optical isolation devices used to maintain sufficient creepage distance from the input terminals dramatically improve noise resistance, provide optimal stability, and achieve a CMRR performance of 80 dB/100 kHz. Add the superior temperature characteristics of ±0.01%/°C and you now have access to a power analyzer that delivers top-of-the-line measurement stability.

\*Device accuracy only

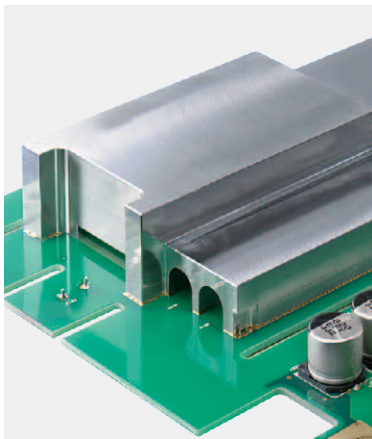

Solid shield

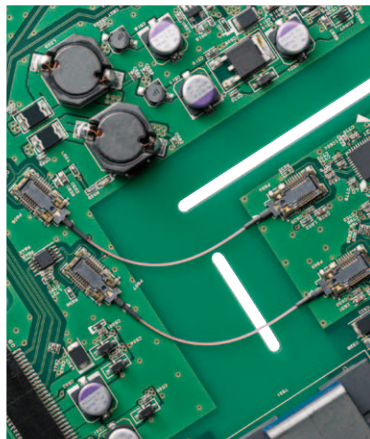

Optical isolation device

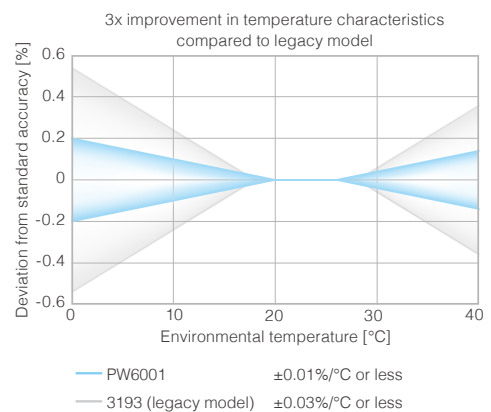

## 18-bit resolution, 5 MS/s sampling

Measurements based on sampling theorem are required to perform an accurate power analysis of PWM waveforms. The Hioki PW6001 features direct sampling of input signals at 5 MS/s, resulting in a measurement band of 2 MHz. This enables analysis without aliasing error.

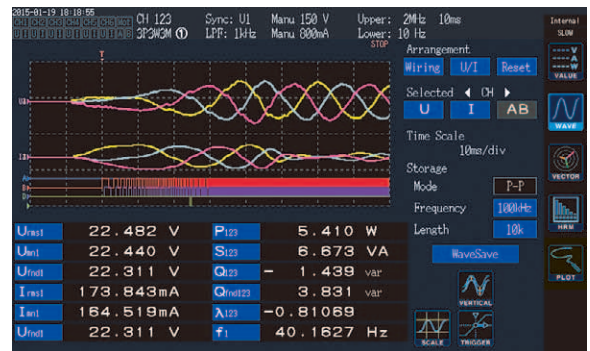

## TrueHD 18-bit converter\* measures widely fluctuating loads with extreme accuracy

A built-in 18-bit A/D converter provides a broad dynamic range. Even loads with large fluctuations can be shown accurately down to tiny power levels without switching the range. Further, a digital LPF is used to remove unnecessary high-frequency noise, for accurate power analysis.

Conversion efficiency measurement during mode measurement without switching ranges

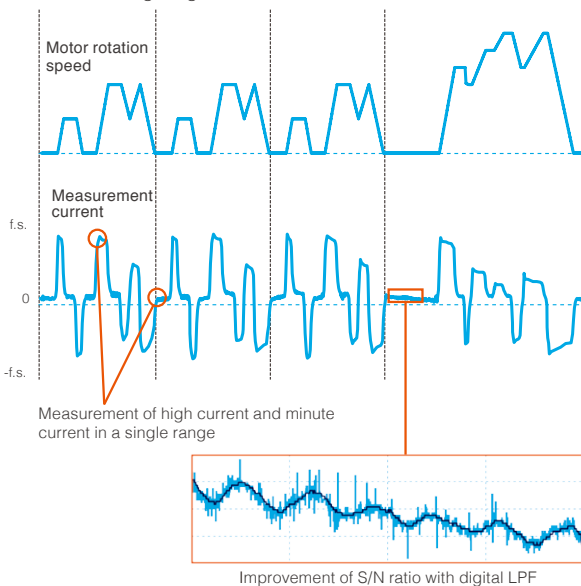

\*True HD : True High Definition

## Achieve lightning fast calculations for 5 independent signal paths at the same time with the Power Analysis Engine II

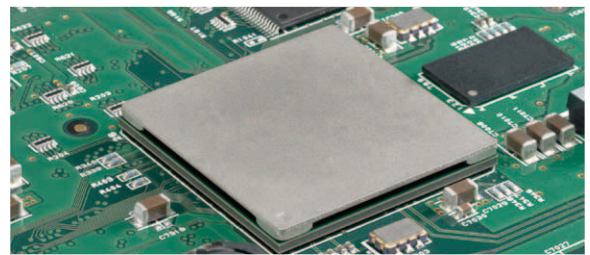

Calculations for up to five independent signal paths (period detection/broadband power analysis/harmonic analysis/waveform analysis/FFT analysis) are independently and digitally processed, eliminating any effects one may have on another. Achieve a 10 ms data update speed while maintaining full accuracy through high-speed processing.

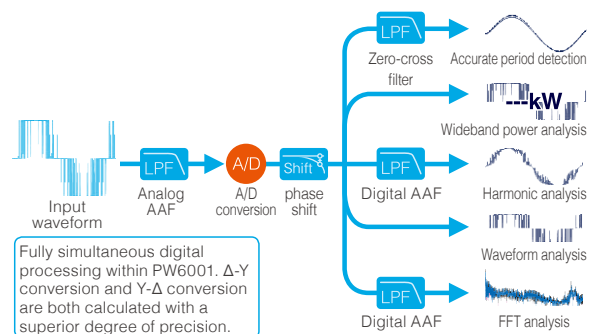

\* AAF (Anti-aliasing filter): This filter prevents aliasing errors during sampling.

# Functions and Characteristics

## Max Speed 10 ms, Maximum 12 ch\* High Accuracy Power Calculation

Data updates in 10 ms to 200 ms. Make high speed calculations while maintaining high accuracy. Achieve measurement stability with original digital filter technology, and measure power after automatically tracking frequency fluctuations from 0.1 Hz.

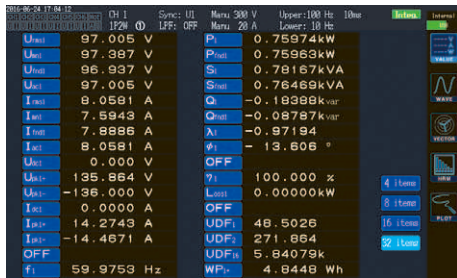

\* Two 6-channel model devices, during synchronized function usage

## Extensive Current Sensor Lineup Achieve a Combined Basic Accuracy of ±0.04%

Choose the best sensor for your application: the pull-through type for highly accurate and high current measurements up to 1000 A, the clamp type for quick and easy wire connection, or the direct input type for high accuracy and broadband. Connect a sensor for oscilloscopes for even more options. PW6001 comes equipped with a sensor power line built-in. Automated recognition functions make setup a cinch.



\*±0.075% = accuracy in combination with PW9100

## Simple, high-precision efficiency and loss calculations

When measuring DC/AC converter efficiency, accuracy is required not only for AC but also DC. The basic DC measurement accuracy of the PW6001 is ±0.02%, enabling you to make accurate and stable efficiency measurements.

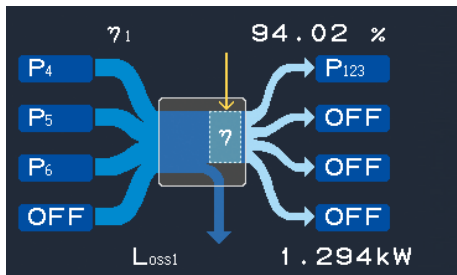

Setting up efficiency calculation formulas for power conditioners and similar equipment is simple on the dedicated screen. Simultaneously display loss and efficiency calculations for a maximum of four systems.

\*Device accuracy

## Ver. 3.00 Large-capacity waveform storage for oscilloscope/ PQA-level waveform analysis

Waveform Storage of 1 MWord × (voltage-current 6 ch + Motor Analysis 4 ch). The torque sensor and encoder signals are displayed along with the voltage and current waveforms.

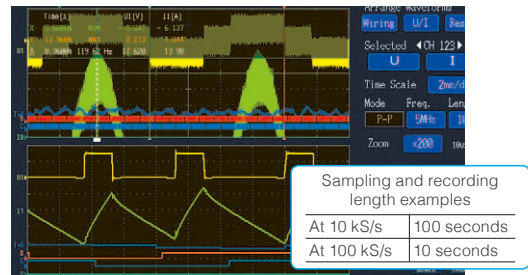

In addition to level triggers, Ver. 3.00 now includes event trigger functions triggered by RMS value and frequency fluctuations. Cursor measurement and waveform zoom functions also render oscilloscopes unnecessary for waveform analysis.

## Independent harmonic analysis for a maximum of 6 systems (wideband/IEC)

0.1 Hz to 300 kHz fundamental frequency, 1.5 MHz analyzable bandwidth. Comes equipped with IEC61000-4-7-compliant harmonic analysis and up to 100th order wideband harmonic analysis.

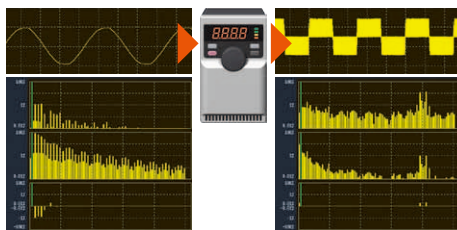

Synchronize inverter input/output and each fundamental wave

### Applications

- Motor fundamental wave analysis
- Wireless power transmission waveforms
- Measuring distortion ratio of power conditioner output waveforms

## FFT analysis of target waveforms

Analyze frequencies up to 2 MHz across 2 channels. Specify any waveform analysis range you like and view the 10 highest peak values and frequencies. Observe frequency components that do not show up in harmonics and save the measured results.



**Ver. 3.00** Newly Added Functions Ver.3.00  
 If you already have the PW6001, these functions will be added with the firmware version update (free of charge).

### Flat Frequency Characteristics

Frequency characteristics are flat up to 1 MHz even when the power factor is zero. Use together with the Current Sensor Phase Shift Function to make highly accurate low power factor measurements of high-frequency waves. Also ideal for loss assessment of high-frequency transformers and reactors.

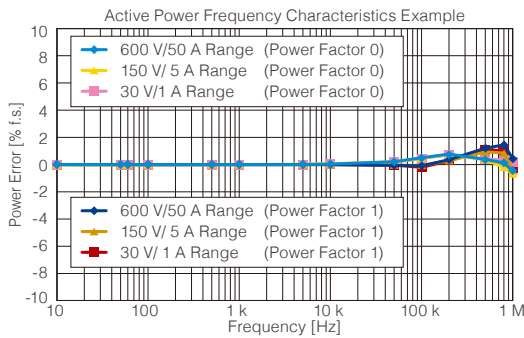

\* Options to further improve high-frequency wave phase characteristics available. Contact us for more information.

### Current Sensor Phase Shift Function

Our original virtual oversampling technology, evolved. Make phase compensation equivalent to 2 GS/s oscilloscopes a reality while maintaining 5 MS/s 18-bit high resolution. Perform current sensor phase compensation with a 0.01° resolution, and measure power more accurately (Ver. 2.00 and later). With the Current Sensor Phase Shift Function, you can now achieve even more accurate high frequency, low power factor power measurements.

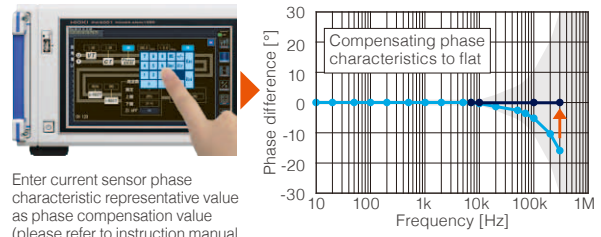

\*Scan the QR code on the right to download a technical brief about current sensor phase shift.



### D/A Monitor

View up to 8 channels of progressive fluctuations in measured values. Voltage, current, power, frequency and other parameters are updated at the fastest rate of 10 ms, allowing you to observe even the tiniest variations.

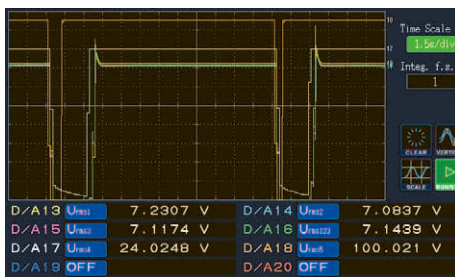

#### Applications

- Power conditioner FRT Analysis
- Motor Transient State Power Analysis

FRT (Fault Ride Through) : Ability to continue operation despite system disturbance in the power conditioner or similar systems

### Complex calculation formulas settable on the device

Set equations to compute measurement values any way you want. Enter up to 16 calculation formulas, including functions like sin and log. Calculation results can be used as parameters for other calculation formulas, enabling complex analysis.

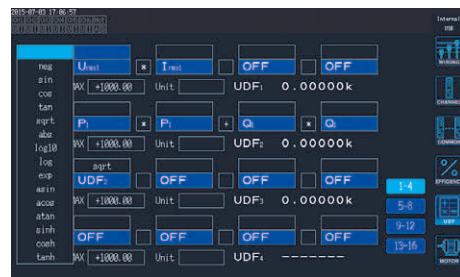

#### Applications

- Calculate multisystem efficiency and loss with solar power modules and similar equipment
- Calculate Ld,Lq for motor vector control
- Calculate transformer current B and H utilizing Epstein's Method

### X-Y Plot

Easily check correlations in measured values for up to two systems simultaneously. Plot physical quantities other than measured values as well by using it together with the user defined calculation function.

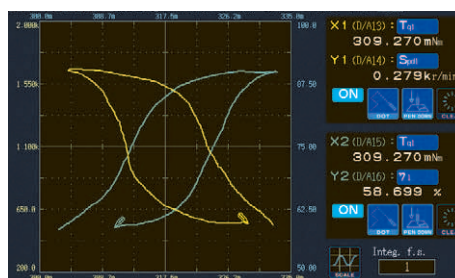

#### Applications

- Motor characteristics analysis
- Transformer characteristics analysis
- Power conditioner MPPT Analysis

MPPT: Maximum Power Point Tracker

### Supports various power analysis systems

Improved connectivity to PCs over LAN. Remotely operate the PW6001 using a browser from any PC, tablet, or smartphone via the HTTP server function. Acquire files through the network with the FTP server function. LabVIEW driver and MATLAB Toolkit are also available.

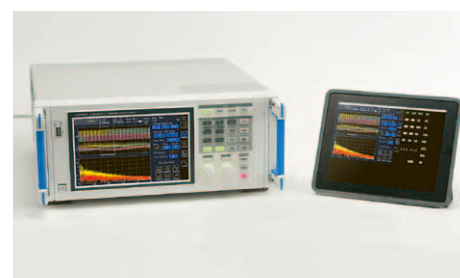

\* LabVIEW is a registered trademark of NATIONAL INSTRUMENTS  
 \*MATLAB is a registered trademark of Mathworks, Inc.

## Specially designed for current sensors to achieve highly precise measurement

### With direct wire connection method

The wiring of the measurement target is routed for connecting to the current input terminal. However, this results in an increase in the effects of wiring resistance and capacitive coupling, and meter loss occurs due to shunt resistance, all of which lead to larger accuracy uncertainty.

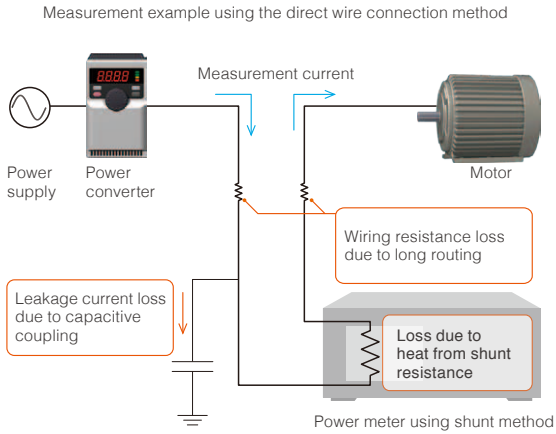

### Advantages of current sensor method

A current sensor is connected to the wiring on the measurement target. This reduces the effects of wiring and meter loss, allowing measurements with wiring conditions that are close to the actual operating environment for a highly efficient system.

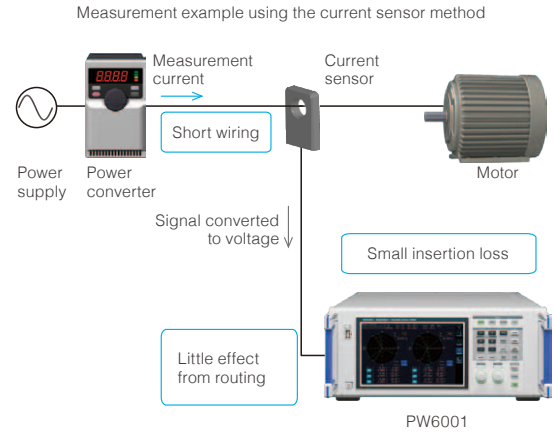

Compared to the direct wire connection method, measurement with conditions closer to the actual operation environment of a power converter is achieved.

## Ver. 3.00 Seamless operability

Simple settings and intuitive operating interface. From Ver. 3.00, a low power factor measurement (LOW PF) mode is included.

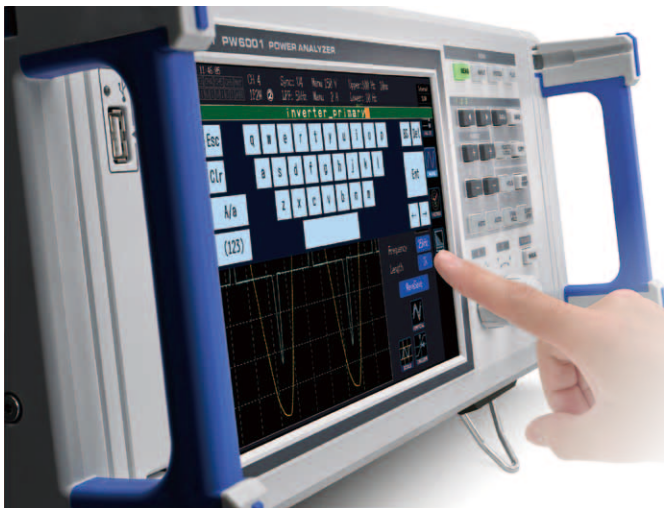

9-inch touch screen with soft keypad

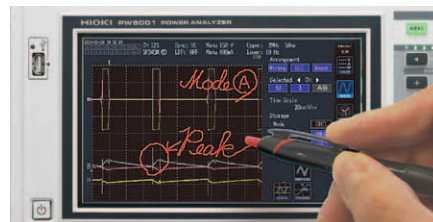

Enter handwritten memos on the screen, or use the onscreen keypad



Dual knobs for vertical/horizontal manipulation of waveforms



One-touch data saving with dedicated key



Quick Configuration screen\*

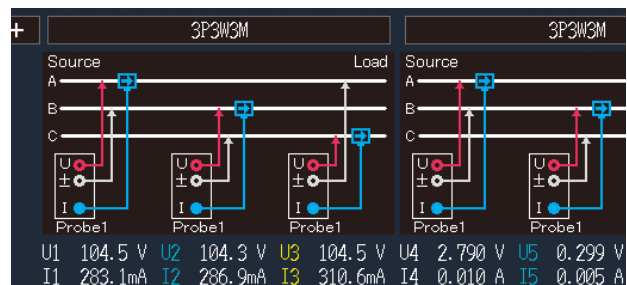

Wiring confirmation function, to avoid wiring mistakes

\* A low power factor measurement (LOW PF) mode for easily setting reactor and transformer loss measurement has been added.

### Build a 12-channel power meter using “numerical synchronization”

For multi-point measurements, use the numerical synchronization function to transfer power parameters from the slave device to aggregate at the master in real-time, essentially enabling you to build a 12-channel power analysis system

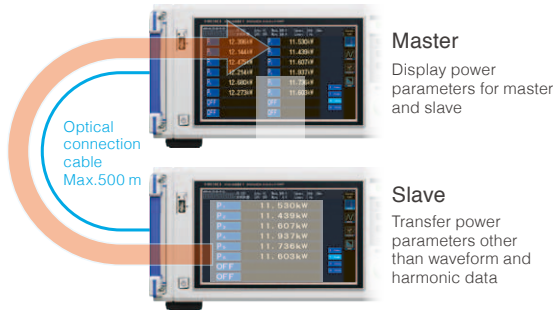

- Real-time display of slave instrument measurement values on master instrument screen
- Real-time efficiency and loss calculations between master and slave instruments
- Save data for 2 units on recording media in master instrument
- Use the slave’s measured values on the master’s user-defined calculations

### Simply transfer waveforms with “waveform synchronization”

Data sampled at 18 bits and 5 MS/s is sent between instruments in real time\*, and the waveform measured by the slave is displayed as-is on the master instrument. This functionality lets you use the power analyzers to measure the voltage phase difference between two remote locations, for example at power substations, manufacturing plants, or railroad facilities.



- Real-time display of slave instrument waveforms on master instrument screen
- Harmonic analysis and fundamental wave analysis for master instrument and slave instrument
- Simultaneously measure waveforms on master device while using the slave to trigger
- D/A output of the slave instrument’s waveform from the master instrument

\* For both master instruments and slave instrument, waveform synchronization operates only when there are 3 or more channels. Max. ±5 sampling error.

### Measure phase difference between 2 separate points

Use the waveform synchronization function to measure the phase relationship between 2 points separated by a maximum distance of 500 m. Due to insulation with an optical connection cable, measurement can be performed safely even if the ground potential between the 2 points is not the same.

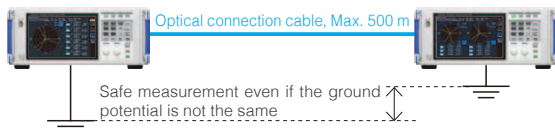

### D/A output waveforms captured 500m away

Transfer voltage/current waveforms taken by the slave instrument located as far as 500m away and output the signals from the master device. When combined with a Hioki MEMORY HiCORDER, timing tests and simultaneous analysis of multiple channels for 3-phase power are possible.

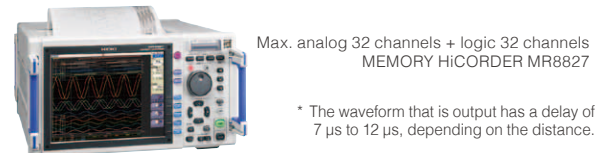

### Wide range of Motor Analysis functions

(Motor Analysis and D/A output model)

Enter signals from torque meters and speed meters to measure motor power. In addition to motor parameters such as motor power and electrical angle, output signals from insulation meters and wind speed meters can also be measured.



Operating mode	Single	Dual	Independent input
ch A	Torque	Torque	Voltage/ Pulse
ch B	Encoder A phase signal	Torque	Voltage/ Pulse
ch C	Encoder B phase signal	RPM	Pulse
ch D	Encoder Z phase signal	RPM	Pulse
Measurement targets	Motor x 1	Motor x 2, Motors, transmissions, etc.	Pyranometer/ anemometer and other output signals
Measurement parameters	Electric angle Rotation direction Motor power RPM Torque Slip	Motor power x 2 RPM x 2 Torque x 2 Slip x 2	Voltage x 2 & Pulse x 2 or Pulse x 4

### Analog Output and 1 MS/s Waveform Output

(Motor Analysis and D/A output model)

Output analog measurement data at update rates of up to 10ms. Combine with a data logger to record long-term fluctuations, and use the built-in waveform output function to output voltage and current at 1 MS/s\*.

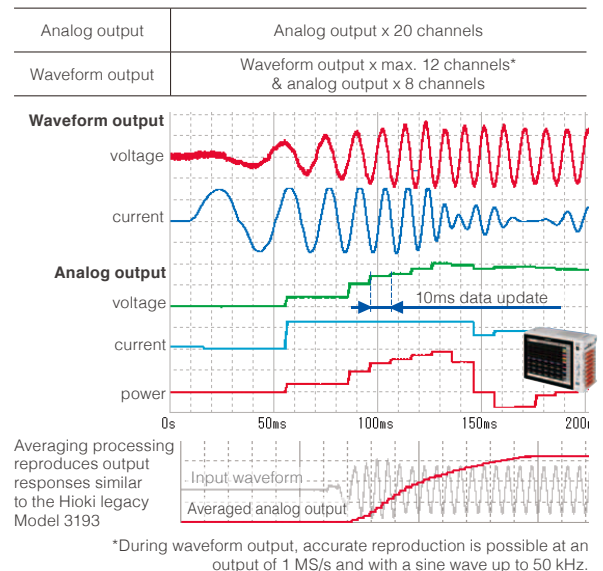

# Applications

## EV/HEV inverter and motor analysis

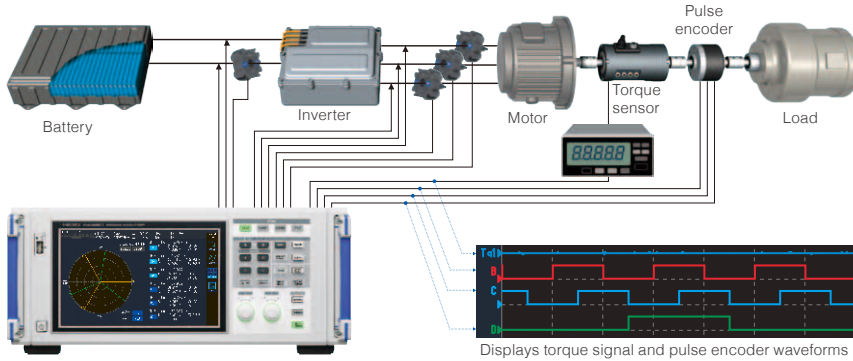

### Key features

- High-speed data update every 10 ms
- 5MS/s high-speed sampling
- ±0.02% DC accuracy
- Wideband mode harmonic analysis
- Flexible efficiency calculation
- Noise resistance
- TrueHD 18-bit resolution
- User-defined calculations
- Current sensor phase shift function
- Z phase synchronization

\*Scan the QR code on the right to download a technical brief about SiC inverter power measurements.



### Ver. 3.00 Calculate transient state power with 10 ms high accuracy and high speed

Measure power transient states, including motor operations such as starting and accelerating, at 10ms update rates. Automatically measure and keep up with power with fluctuating frequencies, from a minimum of 0.1 Hz. Ver. 3.00 increases the stability of efficiency calculations further by delivering a function to calculate the electric power for one motor cycle.

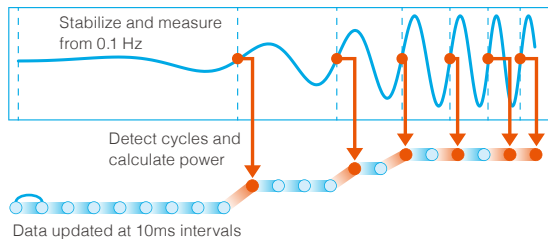

Even during frequency fluctuations from low to high, the fundamental waveform is automatically pursued. Comes equipped with Δ-Y and Y-Δ conversion while calculating with a high degree of accuracy.

### Advanced electrical angle measurement function

Comes equipped with electrical angle measurement necessary for vector control analysis via dq coordination systems as well as high efficiency synchronous motor parameter measurements. Measure voltage and current fundamental wave components based on encoder pulses in real time. In addition, analyze 4 quadrants of torque and rotation through detecting the forward/reverse from A-phasic and B-phasic pulses.

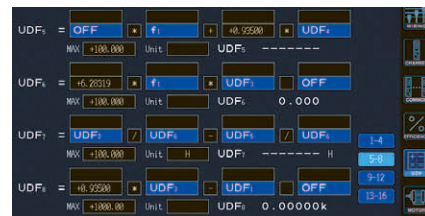

Calculate the  $L_d$  and  $L_q$  values with user-defined operation

Calculation of the d, and q-axis inductances

$$L_d = \frac{vq - Ke\omega - Riq}{\omega id}$$

$$L_q = \frac{Rid - vd}{\omega iq}$$

\*Scan the QR codes on the right to download technical briefs about electrical angle measurements.



### Simultaneous measurement of 2 motor powers

The PW6001 is engineered with the industry's first built-in dual mode motor analysis function that delivers the simultaneous analysis of 2 motors. Simultaneous measurement of the motor power for HEV driving and power generation is now possible.

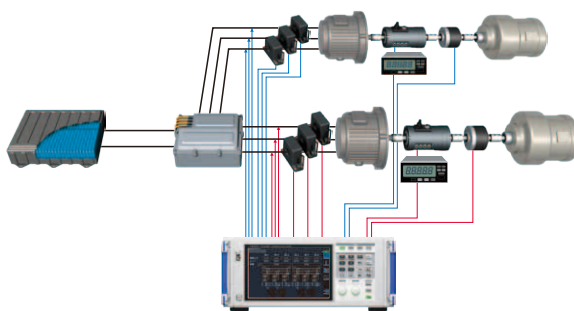

Example of 2 motor measurement

### Evaluate inverter motor efficiency and loss

Evaluate efficiency and loss for an inverter, motor, and overall system by simultaneously measuring the inverter's input and output power and the motor's output. You can also create an efficiency map or loss map in MATLAB using measurement results recorded by the PW6001 at each operating point.

\*MATLAB is a registered trademark of Mathworks, Inc.

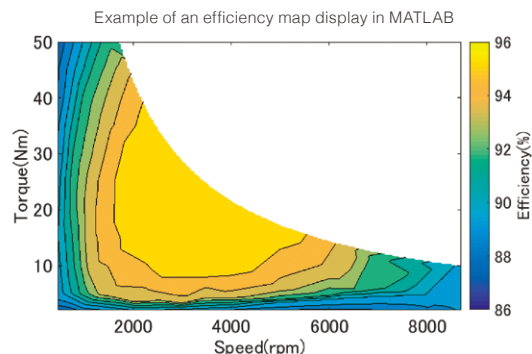

# Chopper circuit reactor loss measurement

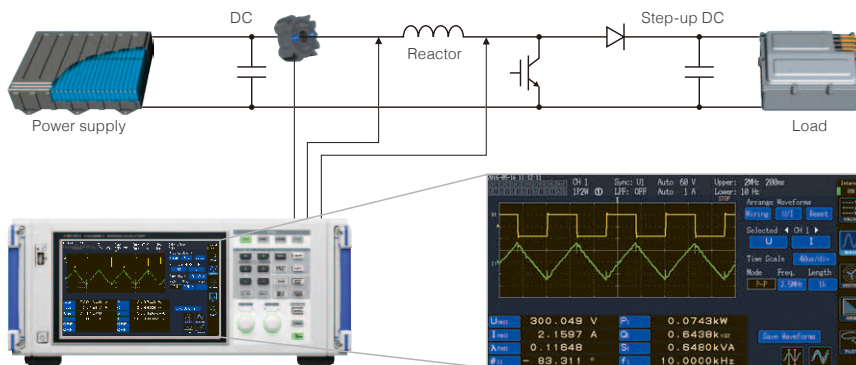

### Key features

- TrueHD 18-bit resolution
- 80dB/100 kHz CMRR
- 5MS/s high-speed sampling
- Current sensor phase shift function
- Wideband mode harmonic analysis
- Noise resistance
- User-defined calculations

\*Scan the QR code on the right to download a technical brief about reactor loss measurements.



## Ver. 3.00 High-frequency and low power factor device evaluation

Reactors are used for high harmonic current suppression as well as the voltage step up/down of chopper circuits. The PW6001's outstanding high frequency characteristics, high-speed sampling, and noise-suppressing performance are extremely effective in evaluating high-frequency, low power factor devices (reactors, transformers, etc.). With the addition of a low power factor measurement (LOW PF) mode to the Quick Configuration menu in Ver. 3.00, measurements can now be performed even more quickly.

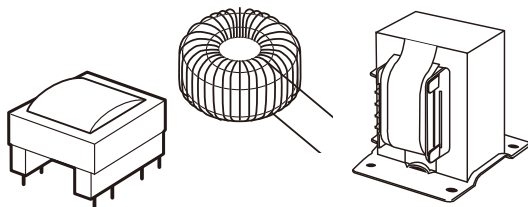

## Current Sensor Phase Shift Function

In addition to the PW6001's flat, broad frequency characteristics, sensor phase error compensation allows highly accurate high-frequency and low power factor device analysis.

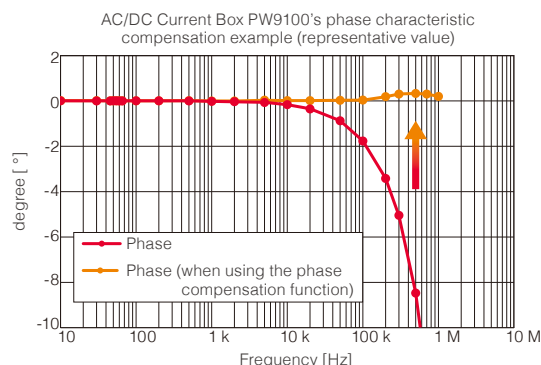

## Harmonic analysis synchronized with switching frequencies

With the PW6001 you can perform harmonic analysis of fundamental waves up to 300 kHz with a band frequency of 1.5 MHz. For reactors used by chopper circuits, measure phase angles and RMS values for the current and voltage of each harmonic order through harmonic analysis synchronized with the switching frequency.



## Circuit impedance analysis

Calculate circuit impedance, resistance, and inductance by using harmonic analysis results and user defined calculations. X-Y plot functions are especially effective for impedance analysis.

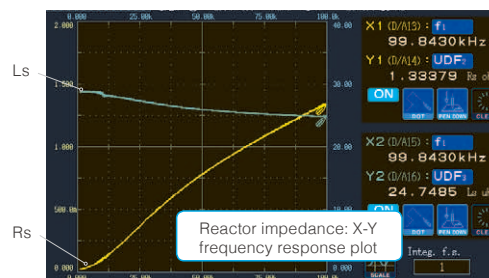

- Impedance  $Z [\Omega]$   
= fundamental frequency voltage / fundamental frequency current
- Serial resistance  $R_S [\Omega]$   
=  $Z \times \cos(\text{voltage phase angle} - \text{current phase angle})$
- Serial inductance  $L_S [H]$   
=  $Z \times \sin(\text{voltage phase angle} - \text{current phase angle}) / (2 \times \pi \times \text{frequency})$

# PV/Wind turbine Power Conditioner (PCS) Efficiency Measurement

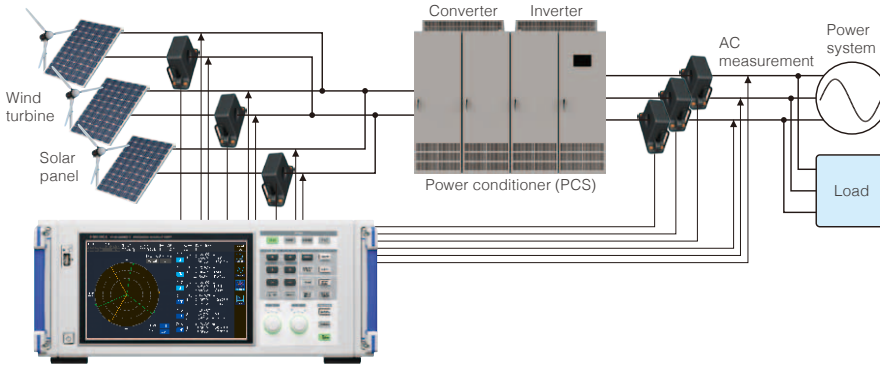

### Key features

±0.02% DC accuracy	±0.01 Hz frequency accuracy
Various measurement parameters	Event triggers
Independent input for Motor Analysis	2-system vector display
Integration of purchased electricity	IEC mode harmonic analysis

## Supports PCS-specific measurements

Simultaneously display the necessary parameters for PCS such as efficiency, loss, fundamental wave reactive power Qfnd, DC ripple ratio, three-phase unbalanced factor, etc. Easily check the required measured items for improved test efficiency. In addition, by setting the DC power sync source to the output AC power channel, you can perform DC output and stable efficiency measurements perfectly synchronized with the output AC.

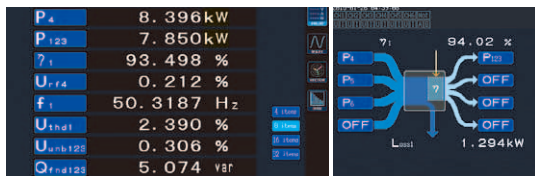

- P4: DC power (panel output)
- P123: 3-phase power (power conditioner output)
- Urf4: Ripple rate
- η1: Conversion efficiency
- f1: Frequency
- Uthd1: Voltage total harmonic distortion
- Uunb123: Unbalance rate
- Qfnd123: Fundamental wave reactive power

## Harmonic analysis and conductive noise evaluation

The PW6001 can perform IEC standard-based harmonic measurements that comply with IEC 61000-4-7. In wind power generation, where the generator hardware and grid operate at different frequencies, dual vector displays let you identify the tri-phase equilibrium at a glance. In addition, FFT analysis lets you to evaluate conductive noise generated by devices such as switching power supplies from 2 kHz to 150 kHz.

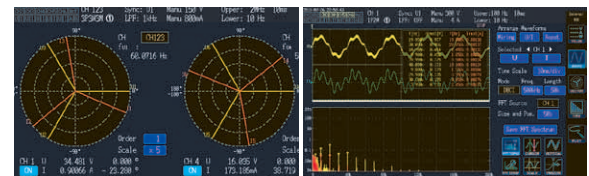

Measure output harmonics and noise through input waveform FFT analysis

### Ver. 3.00 Use event triggers to analyze waveforms

An event trigger function is now available with Ver.3.00. Set triggers for up to four measurement items, such as RMS value and frequency, and record waveforms during an event for up to 100 seconds. If you need to record waveforms for more than 100 seconds, use the D/A output function (Motor Analysis & D/A output option) to observe and record waveforms with a recorder, simplifying the evaluation system. (It is not necessary to connect a differential probe or current probe to the recorder.)

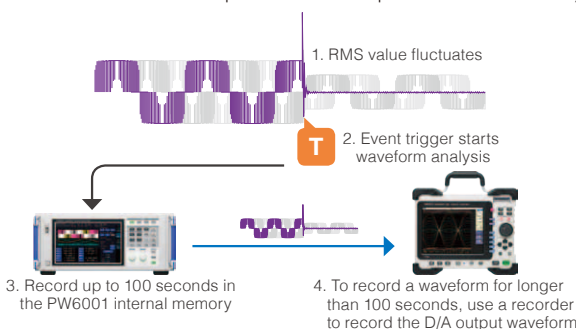

### Voltage frequency measurement fundamental accuracy of ±0.01 Hz\*

Perform frequency measurements required for each PCS test with world-class accuracy and stability. Achieve highly accurate frequency measurement values for a maximum of 6 ch (12 ch when there are two devices) while measuring each parameter at the same time.

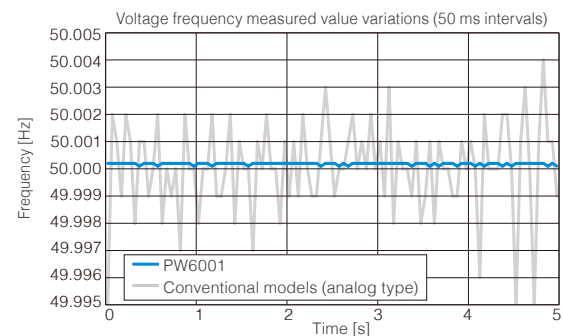

\* ±0.01 Hz fundamental accuracy is defined for cases where the data update is over 50 ms. Please contact us for even more precise frequency measurement.

# Measure the efficiency of wireless power transmission (WPT)

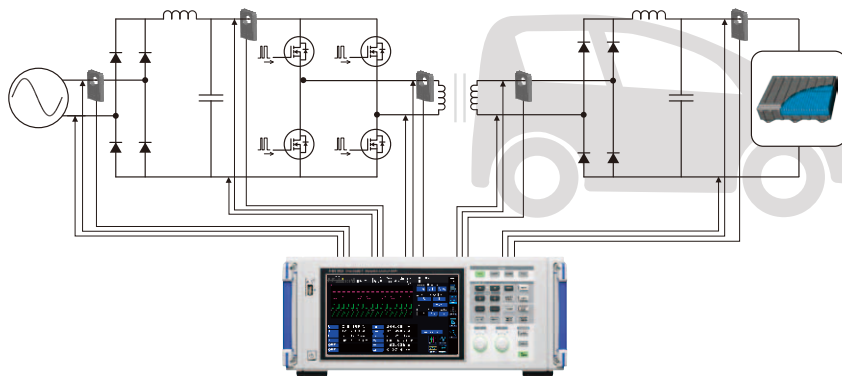

**Key features**

TrueHD 18-bit resolution	80dB/100 kHz CMRR
5MS/s high-speed sampling	Current sensor phase shift function
Wideband mode harmonic analysis	2-system vector display
Noise resistance	IEC mode harmonic analysis

## Accurate measurement, even of low-power-factor power

In wireless power transfer / transmission (WPT), the inductance component of the energy transmit and receive elements lowers the power factor. The PW6001's current sensor phase shift function can be used to accurately measure high-frequency, low-power-factor power. In WPT measurement, it's extremely effective to combine the PW6001 with a high-bandwidth current measurement tool.



Frequency band:  
DC to 3.5 MHz (-3 dB)  
PW9100



Frequency band:  
DC to 4 MHz  
CT6904

## Analyze transmission frequency harmonics

The PW6001's harmonic analysis function can analyze fundamental harmonics of up to 300 kHz at a bandwidth of up to 1.5 MHz. For example, with a circuit that uses an 85 kHz band switching frequency (a frequency that could be used in power transmission in electric vehicle applications) as the fundamental harmonic, the analyzer is capable of simultaneously measuring voltage, current, power, and phase angle for both receive and transmit through the 15th order.



Harmonic bar graph display



Harmonic two-circuit vector display

## Automatic WPT TEST SYSTEM (For more information, please see the TS2400 product catalog.)

The WPT Evaluation System TS2400 is a system for automatically measuring the reproducible data that is required to evaluate WPT hardware by integrating measurement with an XYZ stage. A single software package provides control and automatic measurement functionality for instrument configuration, transmit and receive device positioning, and data collection. The results of analyses can be presented using a variety of bar graphs.



WPT TEST SYSTEM TS2400

WPT evaluation supports the following types of measurement:

- Power transfer efficiency measurement (using the PW6001)
- Automatic coupling coefficient measurement
- Voltage/temperature logging
- Magnetic flux density logging

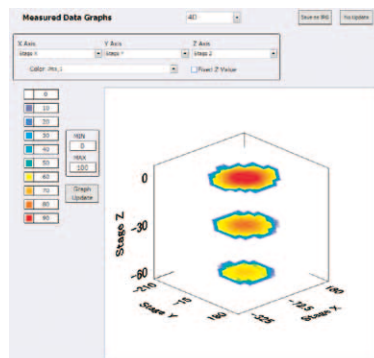

Example of a 4D graph of transfer efficiency

# Interfaces

## Names of parts

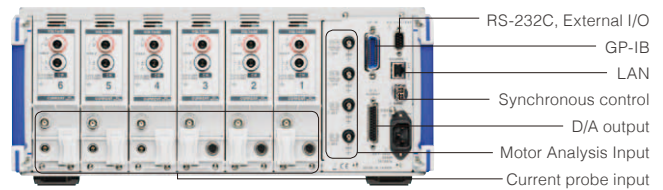

GP-IB	Data viewable through dedicated application Command control
	Data viewable through dedicated application Command control Bluetooth® logger connection
RS-232C	Send the D/A output of values measured with the PW6001 (maximum of 8 items) wirelessly to the Hioki Wireless Logging Station LR8410 using the dedicated cable and Bluetooth® serial conversion adapter. (Approx. 30m* line of sight)The observable output resolution is dependent on the LR8410's resolution. * The presence of obstructions (walls, metal, etc.) may shorten the communication range or destabilize the signal. * Bluetooth® is a trademark of Bluetooth SIG, Inc. and licensed for use by HIOKI E.E. CORPORATION.
External I/O	START/ STOP/ DATA RESET control Terminals shared with RS-232C, ±5 V/200 mA power supply possible
LAN	Gbit LAN supported Command control View data in free dedicated application

Synchronous control	Optical connection cable connector, Duplex-LC (2-core)
D/A output (PW6001-11 to 16 only)	Switching for 20 channels of analog output or maximum 12 channels of waveform + 8 channels of analog output
Current probe input component	Power can also be supplied from the PW6001 to Probe1 or Probe2 by using the sliding cover.
Motor Analysis input component	Input signals from torque meters or rotation meters to measure motor power. Measure motor signals including electric angle and motor power from instruments such as actinometers and anemometers.
USB flash drive	Save waveform data/measured data (csv) Save screen copy (bmp) Save interval data (csv) in real time at the fastest interval of 10 ms
64 MB internal memory	Save interval data and send it to a USB flash drive later

Download the communication command manual from the HIOKI website at [www.hioki.com](http://www.hioki.com)

# Software

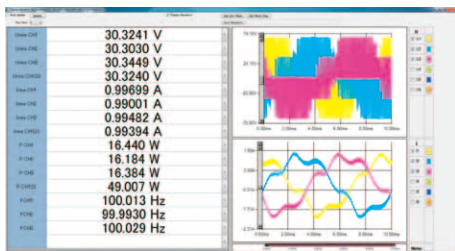
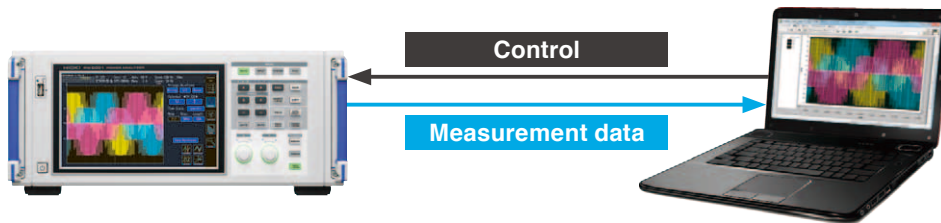

PW Communicator

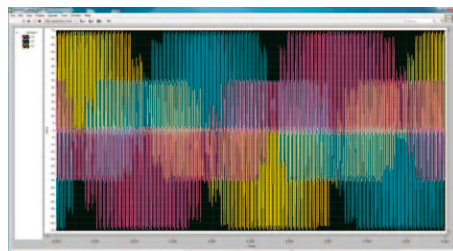

LabVIEW \*

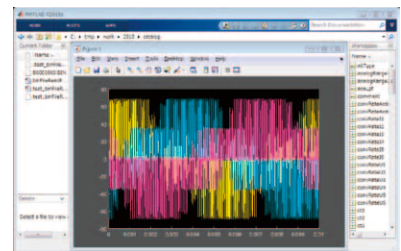

MATLAB \*

## PC Communication Software – PW Communicator

PW Communicator is a free application that connects to the PW6001 via a communications interface (Ethernet, RS-232C, or GP-IB), making it easy to configure the instrument's settings and to monitor or save measured values and waveform data from a computer. The software can simultaneously connect to up to 8 Hioki power measuring instruments, including the PW6001, Power Analyzer PW3390, Power Meter PW3335, PW3336, and PW3337, and it can provide integrated control over multiple models. The software can also be used to simultaneously save measurement data on the computer and calculate efficiency between instruments.

## LabVIEW driver and MATLAB toolkit

Hioki's LabVIEW driver and MATLAB toolkit can be used to build data collection and measurement systems. We also offer a number of sample programs to help you get started.

\*LabVIEW is a registered trademark of National Instruments.

\*MATLAB is a registered trademark of Mathworks, Inc.

Download the software and drivers from the HIOKI website at [www.hioki.com](http://www.hioki.com)

# Specifications

## Power measurement

Measurement lines	1-phase/2-wire (1P2W), 1-phase/3-wire (1P3W), 3-phase/3-wire (3P3W2M, 3V3A, 3P3W3M), 3-phase/4-wire (3P4W)					
	CH1	CH2	CH3	CH4	CH5	CH6
Pattern 1	1P2W	1P2W	1P2W	1P2W	1P2W	1P2W
Pattern 2	1P3W / 3P3W2M		1P2W	1P2W	1P2W	1P2W
Pattern 3	1P3W / 3P3W2M		1P2W	1P3W / 3P3W2M		1P2W
Pattern 4	1P3W / 3P3W2M		1P3W / 3P3W2M		1P3W / 3P3W2M	
Pattern 5	3P3W3M / 3V3A / 3P4W			1P2W	1P2W	
Pattern 6	3P3W3M / 3V3A / 3P4W			1P3W / 3P3W2M		1P2W
Pattern 7	3P3W3M / 3V3A / 3P4W			3P3W3M / 3V3A / 3P4W		
	For 2-channel combinations, select 1P3W or 3P3W2M. For 3-channel combinations, select 3P3W3M, 3V3A, or 3P4W.					
Number of channels	1	2	3	4	5	6
Pattern 1	✓	✓	✓	✓	✓	✓
Pattern 2	-	✓	✓	✓	✓	✓
Pattern 3	-	-	✓	-	-	✓
Pattern 4	-	-	-	✓	-	✓
Pattern 5	-	-	✓	✓	✓	✓
Pattern 6	-	-	-	-	✓	✓
Pattern 7	-	-	-	-	-	✓
	Connection patterns that can be selected based on the number of channels: [✓] Can be selected, [-] Cannot be selected					
Number of input channels	Max. 6 channels; each input unit provides 1 channel for simultaneous voltage and current input					
Input terminal profile	Voltage	Plug-in terminals (safety terminals)				
	Probe 1	Dedicated connector (ME15W)				
	Probe 2	BNC (metal) + power supply terminal				
Probe 2 power supply	+12 V ±0.5 V, -12 V ±0.5 V, max. 600 mA, up to a max. of 700 mA for up to 3 channels					
Input method	Voltage measurement unit	Photoisolated input, resistance voltage divider				
	Current measurement unit	Isolated input from current sensor (voltage output)				
Voltage range	6 V / 15 V / 30 V / 60 V / 150 V / 300 V / 600 V / 1500 V					
Current range (Probe 1)	400 mA / 800 mA / 2 A / 4 A / 8 A / 20 A		(with 20 A sensor)			
	4 A / 8 A / 20 A / 40 A / 80 A / 200 A		(with 200 A sensor)			
	1 A / 2 A / 5 A / 10 A / 20 A / 50 A		(with 50 A sensor)			
	10 A / 20 A / 50 A / 100 A / 200 A / 500 A		(with 500 A sensor)			
	20 A / 40 A / 100 A / 200 A / 400 A / 1 kA		(with 1000 A sensor)			
(Probe 2)	1 kA / 2 kA / 5 kA / 10 kA / 20 kA / 50 kA (with 0.1 mV/A sensor)					
	100 A / 200 A / 500 A / 1 kA / 2 kA / 5 kA (with 1 mV/A sensor)					
	10 A / 20 A / 50 A / 100 A / 200 A / 500 A (with 10 mV/A sensor; with 3274 or 3275)					
	1 A / 2 A / 5 A / 10 A / 20 A / 50 A (with 100 mV/A sensor; with 3273 or 3276)					
	100 mA / 200 mA / 500 mA / 1 A / 2 A / 5 A (with 1 V/A sensor; with CT6700 or CT6701)					
	(0.1 V / 0.2 V / 0.5 V / 1.0 V / 2.0 V / 5.0 V range)					
Power range	2.40000 W to 4.50000 MW (depending on voltage and current combinations)					
Crest factor	3 (relative to voltage/current range rating); however, 1.33 for 1500 V range, 1.5 for 5 V Probe 2 range 300 (relative to minimum valid voltage and current input); however, 133 for 1500 V range, 150 for 5 V Probe 2 range					
Input resistance (50 Hz / 60 Hz)	Voltage inputs	4 MΩ ±40 kΩ		Probe 2 inputs	1 MΩ ±50 kΩ	
	Probe 1 inputs	1 MΩ ±50 kΩ		Probe 2 inputs	1 MΩ ±50 kΩ	
Maximum input voltage	Voltage inputs	1000 V, ±2000 Vpeak (10 ms or less) Input voltage frequency of 250 kHz to 1 MHz, (1250 - f) V Input voltage frequency of 1 MHz to 5 MHz, 50 V Unit for f above: kHz				
	Probe 1 inputs	5 V, ±12 Vpeak (10 ms or less)				
	Probe 2 inputs	8 V, ±15 Vpeak (10 ms or less)				
Maximum rated voltage to earth	Voltage input terminal (50 Hz/60 Hz) CATIII 600V; anticipated transient overvoltage: 6000V CATIII 1000V; anticipated transient overvoltage: 6000V					
Measurement method	Voltage/current simultaneous digital sampling with zero-cross synchronized calculation					
Sampling	5 MHz / 18 bits					
Frequency band	DC, 0.1 Hz to 2 MHz					
Synchronization frequency range	0.1 Hz to 2 MHz					
Synchronization source	U1 to U6, I1 to I6, DC (fixed at data update rate), Ext1 to Ext2, Zph, CH C, CH D The zero-cross point of the waveform after passing through the zero-cross filter is used as the standard for U or I selection.					
Data update rate	10 ms / 50 ms / 200 ms When using simple averaging, the data update rate varies based on the number of averaging iterations.					
LPF	500 Hz / 1 kHz / 5 kHz / 10 kHz / 50 kHz / 100 kHz / 500 kHz / OFF Approx. 500 kHz analog LPF + digital IIR filter (Butterworth characteristics equivalent) Except when off, add ±0.1% rdg. to the accuracy. Defined for frequencies that are less than or equal to 1/10 of the set frequency.					
Polarity detection voltage	Current zero-cross timing comparison					
Measurement parameters	Voltage (U), current (I), active power (P), apparent power (S), reactive power (Q), power factor (λ), phase angle (φ), frequency (f), efficiency (η), loss (Loss), voltage ripple factor (Urf), current ripple factor (Irf), current integration (Ih), power integration (WP), voltage peak (Upk), current peak (Ipk)					
Effective measurement range	Voltage, current, power: 1% to 110% of range					
Zero-suppression range	Select from OFF / 0.1% f.s. / 0.5% f.s. When set to OFF, a value may be displayed even when receiving zero input.					
Zero-adjustment	Zero-adjustment of input offsets that are less than ±10% f.s. for voltage and ±10% f.s. ±4 mV for current					

Accuracy	Sine wave input with a power factor of 1 or DC input, terminal-to-ground voltage of 0 V, after zero-adjustment Within the effective measurement range	
	Voltage (U)	Current (I)
DC	±0.02% rdg. ±0.03% f.s.	±0.02% rdg. ±0.03% f.s.
0.1 Hz ≤ f < 30 Hz	±0.1% rdg. ±0.2% f.s.	±0.1% rdg. ±0.2% f.s.
30 Hz ≤ f < 45 Hz	±0.03% rdg. ±0.05% f.s.	±0.03% rdg. ±0.05% f.s.
45 Hz ≤ f < 66 Hz	±0.02% rdg. ±0.02% f.s.	±0.02% rdg. ±0.02% f.s.
66 Hz < f ≤ 1 kHz	±0.03% rdg. ±0.04% f.s.	±0.03% rdg. ±0.04% f.s.
1 kHz < f ≤ 50 kHz	±0.1% rdg. ±0.05% f.s.	±0.1% rdg. ±0.05% f.s.
50 kHz < f ≤ 100 kHz	±0.01x% rdg. ±0.2% f.s.	±0.01x% rdg. ±0.2% f.s.
100 kHz < f ≤ 500 kHz	±0.008x% rdg. ±0.5% f.s.	±0.008x% rdg. ±0.5% f.s.
500 kHz < f ≤ 1 MHz	±(0.021x-7)% rdg. ±1% f.s.	±(0.021x-7)% rdg. ±1% f.s.
Frequency band	2 MHz (-3 dB, typical)	2 MHz (-3 dB, typical)
	Active power (P)	Phase difference
DC	±0.02% rdg. ±0.05% f.s.	-
0.1 Hz ≤ f < 30 Hz	±0.1% rdg. ±0.2% f.s.	±0.1°
30 Hz ≤ f < 45 Hz	±0.03% rdg. ±0.05% f.s.	±0.05°
45 Hz ≤ f < 66 Hz	±0.02% rdg. ±0.03% f.s.	±0.05°
66 Hz < f ≤ 1 kHz	±0.04% rdg. ±0.05% f.s.	±0.05°
1 kHz < f ≤ 10 kHz	±0.15% rdg. ±0.1% f.s.	±0.4°
10 kHz < f ≤ 50 kHz	±0.15% rdg. ±0.1% f.s.	±(0.040x)°
50 kHz < f ≤ 100 kHz	±0.012x% rdg. ±0.2% f.s.	±(0.050x)°
100 kHz < f ≤ 500 kHz	±0.009x% rdg. ±0.5% f.s.	±(0.055x)°
500 kHz < f ≤ 1 MHz	±(0.047x-19)% rdg. ±2% f.s.	±(0.055x)°
	<ul style="list-style-type: none"> <li>- Unit for f in accuracy calculations as mentioned in the table above: kHz</li> <li>- Voltage and current DC values are defined for Udc and Idc, while frequencies other than DC are defined for Urms and Irms.</li> <li>- When U or I is selected as the synchronization source, accuracy is defined for source input of at least 5% f.s.</li> <li>- The phase difference is defined for a power factor of zero during f.s. input.</li> <li>- Add the current sensor accuracy to the above accuracy figures for current, active power, and phase difference.</li> <li>- For the 6 V range, add ±0.05% f.s. for voltage and active power.</li> <li>- Add ±20 μV to the DC accuracy for current and active power when using Probe 1 (however, 2 V f.s.).</li> <li>- Add ±0.05% rdg. ±0.2% f.s. for current and active power when using Probe 2, and add ±0.2° to the phase at or above 10 kHz.</li> <li>- The accuracy figures for voltage, current, active power, and phase difference for 0.1 Hz to 10 Hz are reference values.</li> <li>- The accuracy figures for voltage, active power, and phase difference in excess of 220 V from 10 Hz to 16 Hz are reference values.</li> <li>- The accuracy figures for voltage, active power, and phase difference in excess of 750 V for values of f such that 30 kHz &lt; f ≤ 100 kHz are reference values.</li> <li>- The accuracy figures for voltage, active power, and phase difference in excess of (22000/f [kHz]) V for values of f such that 100 kHz &lt; f ≤ 1 MHz are reference values.</li> <li>- Add ±0.02% rdg. for voltage and active power at or above 1000 V (however, figures are reference values).</li> <li>- Even for input voltages that are less than 1000 V, the effect will persist until the input resistance temperature falls.</li> <li>- For voltages in excess of 600 V, add the following to the phase difference accuracy: <ul style="list-style-type: none"> <li>- 500 Hz &lt; f ≤ 5 kHz: ±0.3°</li> <li>- 5 kHz &lt; f ≤ 20 kHz: ±0.5°</li> <li>- 20 Hz &lt; f ≤ 200 kHz: ±1°</li> </ul> </li> </ul>	
	Measurement parameters	Accuracy
	Apparent power	Voltage accuracy + current accuracy ±10 dgt.
	Reactive power	Apparent power accuracy + ( $\sqrt{2.69 \times 10^{-4} \times f + 1.0022 \times \lambda^2 - \sqrt{1 - \lambda^2}}$ ) × 100% f.s.
	Power factor	φ of other than ±90°: $\pm \left( 1 - \frac{\cos(\phi + \text{phase difference accuracy})}{\cos(\phi)} \right) \times 100\% \text{rdg.} \pm 50 \text{dgt.}$ φ of ±90°: ±cos(φ + phase difference accuracy) × 100% f.s. ±50 dgt.
	Waveform peak	Voltage/current RMS accuracy ±1% f.s. (f.s.: apply 300% of range)
	f: kHz; φ: Display value for voltage/current phase difference; λ: Display value for power factor	
Effects of temperature and humidity	Add the following to the voltage, current, and active power accuracy within the range of 0°C to 20°C or 26°C to 40°C: ±0.01% rdg./°C (add 0.01% f.s./°C for DC measured values) For current and active power when using Probe 2, ±0.02% rdg./°C (add 0.05% f.s./°C for DC measured values) Under conditions of 60% RH or greater: Add ±0.0006 × humidity [%RH] × f [kHz] rdg. to the voltage and active power accuracy. Add ±0.0006 × humidity [%RH] × f [kHz]° for the phase difference.	
Effects of common-mode voltage	50 Hz/60 Hz : 100 dB or greater (when applied between the voltage input terminals and the enclosure) 100 kHz : 80 dB or greater (reference value) Defined for CMRR when the maximum input voltage is applied for all measurement ranges.	
Effects of external magnetic fields	±1% f.s. or less (in a magnetic field of 400 A/m, DC or 50 Hz/ 60 Hz)	
Effects of power factor	φ of other than ±90°: $\pm \left( 1 - \frac{\cos(\phi + \text{phase difference accuracy})}{\cos(\phi)} \right) \times 100\% \text{rdg.}$ φ of ±90°: ±cos(φ + phase difference accuracy) × 100% f.s.	

## Frequency measurement

Number of measurement channels	Max. 6 channels (f1 to f6), based on the number of input channels	
Measurement source	Select from U/I for each connection.	
Measurement method	Reciprocal method + zero-cross sampling value correction Calculated from the zero-cross point of waveforms after application of the zero-cross filter.	
Measurement range	0.1 Hz to 2 MHz (Display shows 0.00000 Hz or ----- Hz if measurement is not possible.)	
Accuracy	±0.01Hz	(Only when measuring 45-66 Hz with a minimum measurement interval of 50 ms and sine input of at least 50% relative to the voltage range when measuring the voltage frequency)
	±0.05% rdg ± 1 dgt.	(other than the conditions mentioned above, when the sine wave is at least 30% relative to the measurement source's measurement range)
Display format	0.10000 Hz to 9.99999 Hz, 9.9000 Hz to 99.9999 Hz, 99.000 Hz to 999.999 Hz, 0.99000 kHz to 9.99999 kHz, 9.9000 kHz to 99.9999 kHz, 99.000 kHz to 999.999 kHz, 0.99000 MHz to 2.00000 MHz	

## Integration measurement

Measurement modes	Select RMS or DC for each connection (DC mode can only be selected when using an AC/DC sensor with a 1P2W connection).
Measurement parameters	Current integration (Ih-, Ih-, Ih), active power integration (WP+, WP-, WP) Ih+ and Ih- are measured only in DC mode. Only Ih is measured in RMS mode.
Measurement method	Digital calculation based on current and active power values DC mode Every sampling interval, current values and instantaneous power values are integrated separately for each polarity. RMS mode The current RMS value and active power value are integrated for each measurement interval. Only active power is integrated separately for each polarity.
Display resolution	999999 (6 digits + decimal point), starting from the resolution at which 1% of each range is f.s.
Measurement range	0 to ±9999.99 TAh/TWh
Integration time	10 sec. to 9999 hr. 59 min. 59 sec.
Integration time accuracy	±0.02% rdg. (0°C to 40°C)
Integration accuracy	±(current or active power accuracy) ±integration time accuracy
Backup function	None

## Harmonics measurement

Number of measurement channels	Max. 6 channels, based on the number of built-in channels
Synchronization source	Based on the synchronization source setting for each connection.
Measurement modes	Select from IEC standard mode or wideband mode (setting applies to all channels).
Measurement parameters	Harmonic voltage RMS value, harmonic voltage content ratio, harmonic voltage phase angle, harmonic current RMS value, harmonic current content ratio, harmonic current phase angle, harmonic active power, harmonic power content ratio, harmonic voltage/current phase difference, total voltage harmonic distortion, total current harmonic distortion, voltage unbalance ratio, current unbalance ratio
FFT processing word length	32 bits
Antialiasing	Digital filter (automatically configured based on synchronization frequency)
Window function	Rectangular
Grouping	OFF / Type 1 (harmonic sub-group) / Type 2 (harmonic group)
THD calculation method	THD_F / THD_R (Setting applies to all connections.) Select calculation order from 2nd order to 100th order (however, limited to the maximum analysis order for each mode).

### (1) IEC standard mode

Measurement method	Zero-cross synchronization calculation method (same window for each synchronization source) Fixed sampling interpolation calculation method with average thinning in window IEC 61000-4-7:2002 compliant with gap overlap
Synchronization frequency range	45 Hz to 66 Hz
Data update rate	Fixed at 200 ms.
Analysis orders	0th to 50th
Window wave number	When less than 56 Hz, 10 waves; when 56 Hz or greater, 12 waves
Number of FFT points	4096 points

Accuracy	Frequency	Harmonic voltage and current	Harmonic power	Phase difference
	DC (0th order)		±0.1% rdg. ±0.1% f.s.	±0.1% rdg. ±0.2% f.s.
45 Hz ≤ f ≤ 66 Hz		±0.2% rdg. ±0.04% f.s.	±0.4% rdg. ±0.05% f.s.	±0.08°
66 Hz < f ≤ 440 Hz		±0.5% rdg. ±0.05% f.s.	±1.0% rdg. ±0.05% f.s.	±0.08°
440 Hz < f ≤ 1 kHz		±0.8% rdg. ±0.05% f.s.	±1.5% rdg. ±0.05% f.s.	±0.4°
1 kHz < f ≤ 2.5 kHz		±2.4% rdg. ±0.05% f.s.	±4% rdg. ±0.05% f.s.	±0.4°
2.5 kHz < f ≤ 3.3 kHz		±6% rdg. ±0.05% f.s.	±10% rdg. ±0.05% f.s.	±0.8°

Unit for f in accuracy calculations as mentioned in the table above: kHz

Power is defined for a power factor of 1.

Accuracy specifications are defined for fundamental wave input that is greater than or equal to 50% of the range.

Add the current sensor accuracy to the above accuracy figures for current, active power, and phase difference.

Add ±0.02% rdg. for voltage and active power at or above 1000 V (however, figures are reference values).

Even for input voltages that are less than 1000 V, the effect will persist until the input resistance temperature falls.

### (2) Wideband mode

Measurement method	Zero-cross synchronization calculation method (same window for each synchronization source) with gaps Fixed sampling interpolation calculation method
Synchronization frequency range	0.1 Hz to 300 kHz
Data update rate	Fixed at 50 ms.

Maximum analysis order and Window wave number	Frequency	Window wave number	Maximum analysis order
	0.1 Hz ≤ f < 80 Hz	1	100th
80 Hz ≤ f < 160 Hz	2	100th	
160 Hz ≤ f < 320 Hz	4	60th	
320 Hz ≤ f < 640 Hz	2	60th	
640 Hz ≤ f < 6 kHz	4	50th	
6 kHz ≤ f < 12 kHz	2	50th	
12 kHz ≤ f < 25 kHz	4	50th	
25 kHz ≤ f < 50 kHz	8	30th	
50 kHz ≤ f < 101 kHz	16	15th	
101 kHz ≤ f < 201 kHz	32	7th	
201 kHz ≤ f ≤ 300 kHz	64	5th	

The instrument provides phase zero-adjustment functionality using keys or communications commands (only available when the synchronization source is set to Ext).

Accuracy Add the following to the accuracy figures for voltage (U), current (I), active power (P), and phase difference. (Unit for f in following table: kHz)

Frequency	Harmonic voltage and current	Harmonic power	Phase difference
	DC	±0.1% f.s.	±0.2% f.s.
0.1 Hz ≤ f < 30 Hz	±0.05% f.s.	±0.05% f.s.	±0.1°
30 Hz ≤ f < 45 Hz	±0.1% f.s.	±0.2% f.s.	±0.1°
45 Hz ≤ f ≤ 66 Hz	±0.05% f.s.	±0.1% f.s.	±0.1°
66 Hz < f ≤ 1 kHz	±0.05% f.s.	±0.1% f.s.	±0.1°
1 kHz < f ≤ 10 kHz	±0.05% f.s.	±0.1% f.s.	±0.6°
10 kHz < f ≤ 50 kHz	±0.2% f.s.	±0.4% f.s.	±(0.020xf)° ±0.5°
50 kHz < f ≤ 100 kHz	±0.4% f.s.	±0.5% f.s.	±(0.020xf)° ±1°
100 kHz < f ≤ 500 kHz	±1% f.s.	±2% f.s.	±(0.030xf)° ±1.5°
500 kHz < f ≤ 900 kHz	±4% f.s.	±5% f.s.	±(0.030xf)° ±2°

Unit for f in accuracy calculations as mentioned in the table above: kHz  
The figures for voltage, current, power, and phase difference for frequencies in excess of 300 kHz are reference values.

When the fundamental wave is outside the range of 16 Hz to 850 Hz, the figures for voltage, current, power, and phase difference for frequencies other than the fundamental wave are reference values.

When the fundamental wave is within the range of 16 Hz to 850 Hz, the figures for voltage, current, power, and phase difference in excess of 6 kHz are reference values.

Accuracy values for phase difference are defined for input for which the voltage and current for the same order are at least 10% f.s.

## Waveform recording

Number of measurement channels	Voltage and current waveforms Max. 6 channels (based on the number of installed channels) Motor waveforms * Max. 2 analog DC channels + max. 4 pulse channels
Recording capacity	1 Mword × (voltage + current) × max. 6 channels + motor waveforms Fixed to 1 Mword when the number of channels is low. Motor waveforms: Motor analysis and D/A-equipped models only No memory allocation function
Waveform resolution	16 bits (Voltage and current waveforms use the upper 16 bits of the 18-bit A/D.)
Sampling speed	Voltage and current waveforms Always 5 MS/s Motor waveforms * Always 50 kS/s (analog DC) Motor pulse * Always 5 MS/s
Compression ratio	1/1, 1/2, 1/5, 1/10, 1/20, 1/50, 1/100, 1/200, 1/500 (5 MS/s, 2.5 MS/s, 1 MS/s, 500 kS/s, 250 kS/s, 100 kS/s, 50 kS/s, 25 kS/s, 10 kS/s) However, motor waveforms* are only compressed at 50 kS/s or less.
Recording length	1 kWord / 5 kWord / 10 kWord / 50 kWord / 100 kWord / 500 kWord / 1 Mword
Storage mode	Peak-to-peak compression or simple thinning
Trigger mode	SINGLE or NORMAL (with forcible trigger setting) When FFT analysis is enabled in NORMAL mode, the instrument enters trigger standby and waits for FFT calculations to complete.
Pre-trigger	0% to 100% of the recording length, in 10% steps
Trigger source	Voltage and current waveform, waveform after voltage and current zero-cross filter, manual, motor waveform*, motor pulse*
Trigger slope	Rising edge, falling edge
Trigger level	±300% of the range for the waveform, in 0.1% steps
Trigger detection method	Level trigger / Event trigger (1) Level trigger Detects the trigger based on fluctuations in the level of the storage waveform. Trigger source: Voltage and current waveform, waveform after voltage and current zero-cross filter, manual, motor waveform, motor pulse (motor waveform and motor pulse: Motor analysis and D/A-equipped models only) Trigger slope: Rising edge, falling edge Trigger level: ±300% of the range for the waveform, in 0.1% steps (2) Event trigger Detects the trigger based on fluctuations in the value of the measurement parameter selected for D/A output. Specifically, trigger detection conditions are set using OR and AND operations performed on the four events defined below. Note that the AND operator has precedence over the OR operator. Event: These condition definitions consist of a D/A output measurement parameter (D/A13 to D/A20), an inequality sign (< or >), and a value (0.00000 to 999999T). Evm : D/A n □ X.XXXXX y (m: 1 to 4, n: 13 to 20, □: Inequality sign, X.XXXXX: 6-digit constant, y: SI prefix)

\*Motor waveform and motor pulse: Motor Analysis and D/A-equipped models only

## FFT analysis

Measurement channel	Voltage-Current Waveform - 1 channel (selected from input channels) Motor Waveform - Analog DC Analysis performed only when FFT screen is displayed
Calculation type	RMS spectrum
Number of FFT points	1,000, 5,000, 10,000 or 50,000 points
FFT processing word length	32 bits
Analysis position	Any desired position among the waveform record data
Antialiasing	Automatic Digital Filter (during simple thinning mode) None (During Peak-Peak compression mode, use the Max value and perform FFT)
Window function	Rectangular/Hanning/Flat-top
Max. analysis frequency	Linked with compression ratio of waveform records. 2 MHz, 1 MHz, 400 kHz, 200 kHz, 100 kHz, 40 kHz, 20 kHz, 10 kHz or 4 kHz / 20 kHz, 10 kHz, or 4 kHz during analog DC input (Mentioned above frequency - frequency resolution) becomes the maximum analysis frequency
FFT peak value display	Compute 10 frequencies and voltage-current peak value levels (local maximum value) each starting from the top, ordered by level / For FFT calculation results, recognize as the peak value when the data on both sides is lower than the original data

## Motor Analysis (PW6001-11 to -16 only)

Number of input channels	4 channels: CH A Analog DC input / Frequency input / Pulse input CH B Analog DC input / Frequency input / Pulse input CH C Pulse input CH D Pulse input
Operating mode	Single, dual, or independent input
Input terminal profile	Isolated BNC connectors
Input resistance (DC)	1 MΩ ±50 kΩ
Input method	Function-isolated input and single-end input
Measurement parameters	Voltage, torque, rpm, frequency, slip, motor power
Maximum input voltage	±20 V (analog DC and pulse operation)
Additional conditions for guaranteed accuracy	Input: Terminal-to-ground voltage of 0 V, after zero-adjustment

### (1) Analog DC input (CH A/CH B)

Measurement range	±1 V / ±5 V / ±10 V
Effective input range	1% to 110% f.s.
Sampling	50 kHz, 16 bits
Response speed	0.2 ms (when LPF is OFF)
Measurement method	Simultaneous digital sampling, zero-cross synchronization calculation method (averaging between zero-crosses)
Measurement accuracy	±0.05% rdg. ±0.05% f.s.
Temperature coefficient	±0.03% f.s./°C
Effects of common-mode voltage	±0.01% f.s. or less with 50 V applied between the input terminals and the enclosure (DC / 50 Hz / 60 Hz)
LPF	OFF (20 kHz) / ON (1 kHz)
Display range	From the range's zero-suppression range setting to ±150%
Zero-adjustment	Voltage ±10% f.s., zero-correction of input offsets that are less

### (2) Frequency input (CH A/CH B)

Detection level	Low: 0.5 V or less; high: 2.0 V or more
Measurement frequency band	0.1 Hz to 1 MHz (at 50% duty ratio)
Minimum detection width	0.5 μs or more
Measurement accuracy	±0.05% rdg. ±3 dgt.
Display range	1.000 kHz to 500.000 kHz

### (3) Pulse input (CH A / CH B / CH C / CH D)

Detection level	Low: 0.5 V or less; high: 2.0 V or more
Measurement frequency band	0.1 Hz to 1 MHz (at 50% duty ratio)
Minimum detection width	0.5 μs or more
Pulse filter	OFF / Weak / Strong (When using the weak setting, positive and negative pulses of less than 0.5 μs are ignored. When using the strong setting, positive and negative pulses of 5 μs are ignored.)
Measurement accuracy	±0.05% rdg. ±3 dgt.
Display range	0.1 Hz to 800.000 kHz
Unit	Hz / r/min.
Frequency division setting range	1~60000
Rotation direction detection	Can be set in single mode (detected based on lead/lag of CH B and CH C).
Mechanical angle origin detection	Can be set in single mode (CH B frequency division cleared at CH D rising edge).

## D/A output (PW6001-11 to -16 only)

Number of output channels	20 channels	
Output terminal profile	D-sub 25-pin connector × 1	
Output details	- Switchable between waveform output and analog output (select from basic measurement parameters). - Waveform output is fixed to CH1 to CH12.	
D/A conversion resolution	16 bits (polarity + 15 bits)	
Output refresh rate	Analog output	10 ms / 50 ms / 200 ms (based on data update rate for the selected parameter)
	Waveform output	1 MHz
Output voltage	Analog output	+5 V DC f.s. (max. approx. ±12 V DC)
	Waveform output	Switchable between ±2 V f.s. and ±1 V f.s., crest factor of 2.5 or greater. Setting applies to all channels.
Output resistance	100 Ω ±5 Ω	
Output accuracy	Analog output	Output measurement parameter measurement accuracy ±0.2% f.s. (DC level)
	Waveform output	Measurement accuracy ±0.5% f.s. (at ±2 V f.s.) or ±1.0% f.s. (at ±1 V f.s.) (RMS value level, up to 50 kHz)
Temperature coefficient	±0.05% f.s./°C	

## Display section

Display characters	English, Japanese, Chinese (simplified)	
Display	9" WVGA TFT color LCD (800 × 480 dots) with an LED backlight and analog resistive touch panel	
Display value resolution	999999 count (including integration values)	
Measured values	Approx. 200 ms (independent of internal data update rate) When using simple averaging, the data update rate varies based on the number of averaging iterations.	
Display refresh rate	Waveforms Based on display settings	

## External interface

### (1) USB flash drive interface

Connector	USB Type A connector × 1	
Electrical specifications	USB 2.0 (high-speed)	
Power supplied	Max. 500 mA	
Supported USB flash drives	USB Mass Storage Class compatible	
Recorded data	- Save/load settings files - Save measured values/automatic recorded data (CSV format) - Copy measured values/recorded data (from internal memory) - Save waveform data, save screenshots (compressed BMP format)	

### (2) LAN interface

Connector	RJ-45 connector × 1	
Electrical specifications	IEEE 802.3 compliant	
Transmission method	10Base-T / 100Base-TX / 1000Base-T (automatic detection)	
Protocol	TCP/IP (with DHCP function)	
Functions	HTTP server (remote operations) Dedicated port (data transferring, command control) FTP server (file transferring)	

### (3) GP-IB interface

Communication method	IEEE 488.1 1987 compliant developed with reference to IEEE 488.2 1987 Interface functions: SH1, AH1, T6, L4, SR1, RL1, PP0, DC1, DT1, C0	
Addresses	00 to 30	
Functions	Command control	

### (4) RS-232C interface

Connector	D-sub 9-pin connector × 1, 9-pin power supply compatible, also used for external control	
Communication method	RS-232C, EIA RS-232D, CCITT V.24, and JIS X5101 compliant Full duplex, start stop synchronization, data length of 8, no parity, 1 stop bit	
Flow control	Hardware flow control ON/OFF	
Communications speed	9,600 bps / 19,200 bps / 38,400 bps / 57,600 bps / 115,200 bps / 230,400 bps	
Functions	Command control LR8410 Link supported (dedicated connector is required) Used through exclusive switching with external control interface	

### (5) External control interface

Connector	D-sub 9-pin connector × 1, 9-pin power supply compatible, also used for RS-232C	
Power supplied	OFF/ON (voltage of +5 V, max. 200 mA)	
Electrical specifications	0/5 V (2.5 V to 5 V) logic signals or contact signal with terminal shorted or open	
Functions	Same operation as the [START/STOP] key or the [DATA RESET] key on the control panel Used through exclusive switching with RS-232C	

### (6) Two-instrument synchronization interface

Connector	SFP optical transceiver, Duplex-LC (2-wire LC)	
Optical signal	850 nm VCSEL, 1 Gbps	
Laser class	Class 1	
Fiber used	50/125 μm multi-mode fiber equivalent, up to 500 m	
Functions	Sends data from the connected slave instrument to the master instrument, which performs calculations and displays the results.	

## Auto-range function

Functions	The voltage and current ranges for each connection are automatically changed in response to the input.	
Operating mode	OFF/ON (selectable for each connection)	
Auto-range breadth	Broad	The range is increased by one if the peak value is exceeded for the connection or if there is an RMS value that is greater than or equal to 110% f.s. The range is lowered by two if all RMS values for the connection are less than or equal to 10% f.s.
	Narrow	The range is increased by one if the peak value is exceeded for the connection or if there is an RMS value that is greater than or equal to 105% f.s. The range is lowered by one if all RMS values for the connection are less than or equal to 40% f.s. Voltage range changes when Δ-Y conversion is enabled are determined by multiplying the range by $[\frac{1}{\sqrt{3}}]$

## Time control function

Timer control	OFF, 10 sec. to 9999 hr. 59 min. 59 sec. (in 1 sec. steps)	
Actual time control	OFF, start time/stop time (in 1 min. steps)	
Intervals	OFF / 10 ms / 50 ms / 200 ms / 500 ms / 1 sec. / 5 sec. / 10 sec. / 15 sec. / 30 sec. / 1 min. / 5 min. / 10 min. / 15 min. / 30 min. / 60 min.	

## Hold function

Hold	Stops updating the display with all measured values and holds the value currently being displayed. Used exclusively with the peak hold function.	
Peak hold	Updates the measured value display each time a new maximum value is set. Used exclusively with the hold function.	

## Calculation function

### (1) Rectifier

Functions	Selects the voltage and current values used to calculate apparent and reactive power and power factor.
Operating mode	RMS/mean (Can be selected for each connection's voltage and current.)

### (2) Scaling

VT (PT) ratio	OFF / 0.00001 to 9999.99
CT ratio	OFF / 0.01 to 9999.99

### (3) Averaging (AVG)

Functions	All instantaneous measured values, including harmonics, are averaged.					
Operating mode	OFF / Simple averaging / Exponential averaging					
Operation	Simple averaging	Averaging is performed for the number of simple averaging iterations for each data update cycle, and the output data is updated. The data update rate is lengthened by the number of averaging iterations.				
	Exponential averaging	Data is exponentially averaged using a time constant defined by the data update rate and the exponential averaging response rate. During averaging operation, averaged data is used for all analog output and save data.				
Number of simple averaging iterations	Number of averaging iterations	5	10	20	50	100
	Data update rate	10 ms	50 ms	100 ms	200 ms	500 ms
		50 ms	250 ms	500 ms	1 sec.	2.5 sec.
		200 ms	1 sec.	2 sec.	4 sec.	10 sec.
Exponential averaging response rate	Setting	FAST	MID	SLOW		
	Data update rate	10 ms	0.1 sec.	0.8 sec.	5 sec.	
		50 ms	0.5 sec.	4 sec.	25 sec.	
		200 ms	2.0 sec.	16 sec.	100 sec.	
	These values indicate the time required for the final stabilized value to converge on ±1% when the input changes from 0% f.s. to 90% f.s.					

### (4) User-defined calculations

Functions	User-specified basic measurement parameters are calculated using the specified calculation formulas.
Calculated items	Four basic measured items or constants with a maximum of 6-digits; operators are four arithmetic operators. UDFn = ITEM1 □ ITEM2 □ ITEM3 □ ITEM4 ITEMn : basic measured item, or constant of up to 6 digits □ : any one of +, -, *, /, or / UDFn can also be selected for ITEMn, with calculations performed in the order of n. The functions that can be selected and calculated in regards to each ITEMn are as follows: neg, sin, cos, tan, sqrt, abs, log10 (common logarithm), log (logarithm), exp, asin, acos, atan, sinh, cosh, tanh When a UDFn with an n higher than the current UDF is encountered, previously calculated values are used
Number of allowed calculations	16 formulas (UDF1 to UDF16)
Maximum value setting	Set for each UDFn in the range 1.000 μ to 100.0 T / Functions as a UDFn range
Unit	Up to 6 characters in ASCII for each UDFn

### (5) Efficiency and loss calculations

Calculated items	Active power value (P), fundamental wave active power (Pfund), and motor power (Pm) (Motor Analysis and D/A-equipped models only) for each channel and connection
Number of calculations that can be performed	Four each for efficiency and loss
Formula	Calculated items are specified for Pin(n) and Pout(n) in the following format: Pin = Pin1 + Pin2 + Pin3 + Pin4, Pout = Pout1 + Pout2 + Pout3 + Pout4 $\eta = 100 \times \frac{P_{out}}{P_{in}}$ , Loss =  Pin  -  Pout

### (6) Power formula selection

Functions	Selects the reactive power, power factor, and power phase angle formulas.
Formula	TYPE1 / TYPE2 / TYPE3 TYPE1 Compatible with TYPE1 as used by the Hioki 3193 and 3390. TYPE2 Compatible with TYPE2 as used by the Hioki 3192 and 3193. TYPE3 The sign of the TYPE1 power factor and power phase angle are used as the active power signs.

### (7) Delta conversion

Functions	Δ-Y When using a 3P3W3M or 3V3A connection, converts the line voltage waveform to a phase voltage waveform using a virtual neutral point. Y-Δ When using a 3P4W connection, converts the phase voltage waveform to a line voltage waveform. Voltage RMS values and all voltage parameters, including harmonics, are calculated using the post-conversion voltage.
-----------	---

### (8) Current sensor phase shift calculation

Functions	Compensates the current sensor's harmonic phase characteristics using calculations.
Compensation value settings	Compensation points are set using the frequency and phase difference. Frequency 0.1 kHz to 999.9 kHz (in 0.1 kHz steps) Phase difference 0.00° to ±90.00° (in 0.01° intervals) However, the difference in time calculated from the frequency phase difference can be up to 98 μs in 0.5ns intervals

## Display function

### (1) Connection confirmation screen

Functions	Displays a connection diagram and voltage and current vectors based on the selected measurement lines. The ranges for a correct connection are displayed on the vector display so that the connection can be checked.
Mode at startup	User can select to display the connection confirmation screen at startup (startup screen setting).
Simple settings	Commercial power supply / Commercial power supply high-resolution HD / DC / DC high-resolution HD / PWM / High-frequency / Other

### (2) Vector display screen

Functions	Displays a connection-specific vector graph along with associated level values and phase angles.
-----------	--

### (3) Numerical display screen

Functions	Displays power measured values and motor measured values for up to six instrument channels.
Display patterns	Basic by connection Displays measured values for the measurement lines and motors combined in the connection. Selection display There are four measurement line patterns: U, I, P, and Integ. Creates a numerical display for the measurement parameters that the user has selected from all basic measurement parameters in the location selected by the user. There are 4-, 8-, 16-, and 32-display patterns.

### (4) Harmonic display screen

Functions	Displays harmonic measured values on the instrument's screen.
Display patterns	Display bar graph: Displays harmonic measurement parameters for user-specified channels as a bar graph. Display list: Displays numerical values for user-specified parameters and user-specified channels.

### (5) Waveform display screen

Functions	Displays the voltage and current waveforms and motor waveform.
Display patterns	All-waveform display, waveform + numerical display Cursor measurement supported

## Simplified Graph Function

### (1) D/A Monitor Graph

Functions	Graph measured values chosen as D/A output items in chronological order Illustrated waveforms are Peak-Peak compressed by setting time axis to data at data update rate, and data is not recorded.
Operations	Start and stop drawing with the RUN/STOP button Illustrate the displayed value during hold and peak hold Illustrated data is cleared when Clear button is pressed during changes in settings related to measured values of range and D/A output items
Number of illustrated items	Maximum of 8 items
Illustrated items	Operates simultaneously with D/A output items from CH13 to CH20 settings
Time axis	10 ms/dot to 48 min/dot (Cannot be selected below the data update rate)
Vertical axis	Autoscaling (operates to fit data on screen within screen display range with time axis) Manual (user sets displayed maximum value and minimum value)

### (2) X-Y Plot

Functions	Select horizontal and vertical axis items from fundamental measurement items and display X-Y graph Dot illustrations are done at data update rate, and data is not recorded Illustration data can be cleared / a total of two combinations of graphs can be displayed: X1-Y1 or X2-Y2 Gauge display, displayed max value and min value settings are allowed X1, Y1, X2, and Y2 operate in synchronization with D/A output item settings for CH13, 14, 15, and 16 respectively
-----------	---

## Automatic save function

Functions	Saves the specified measured values in effect for each interval.
Save destination	OFF / Internal memory / USB flash drive
Saved parameters	User-selected from all measured values, including harmonic measured values
Maximum amount of saved data	Internal memory 64 MB (data for approx. 1800 measurements) USB flash drive Approx. 100 MB per file (automatically segmented) x 20 files
Data format	CSV file format

## Manual save function

### (1) Measurement data

Functions	The [SAVE] key saves specified measured values at the time it is pressed. Comment text can be entered for each saved data point, up to a maximum of 20 alphanumeric characters. *The manual save function for measurement data cannot be used while automatic save is in progress.
Save destination	USB flash drive
Saved parameters	User-selected from all measured values, including harmonic measured values
Data format	CSV file format

### (2) Waveform data

Functions	(Within touch panel) Use Save Waveforms Button to save waveform data during that session Input comments for each set of saved data *Cannot be operated when waveform data is invalid during storage and automatic saving
Save destination	USB flash drive - Assign destinations for saved data
Comment entry	OFF/ON - up to 40 letters/symbols
Data format	CSV file format (read-only attribute included), binary file format (BIN format)

### (3) Screenshots

Functions	The [COPY] key saves a screenshot to the save destination. *This function can be used at an interval of 1 sec or more while automatic saving is in progress.
Save destination	USB flash drive
Comment entry	OFF / Text / Handwritten When set to [Text], up to 40 alphanumeric characters When set to [Handwritten], hand-drawn images are pasted to the screen.
Data format	Compressed BMP

### (4) Settings data

Functions	Saves settings information to the save destination as a settings file via functionality provided on the File screen. In addition, previously saved settings files can be loaded and their settings restored on the File screen. However, language and communications settings are not saved.
Save destination	USB flash drive

### (5) FFT data

Functions	(Within touch panel) Use Save FFT Spectrum button to save waveform data during that session Input comments for each set of saved data *Cannot be operated when waveform data is invalid during storage and automatic saving
Save destination	USB flash drive - Assign destinations for saved data
Comment entry	OFF/ON - up to 40 letters/symbols
Data format	CSV file format (with read-only attribute set)

## Two-instrument synchronization function

Functions	Sends data from the connected slave instrument to the master instrument, which performs calculations and displays the results. In numerical synchronization mode, the master instrument operates as a power meter with up to 12 channels. In waveform synchronization mode, the master instrument operates while synchronizing up to three channels from the slave instrument at the waveform level.
Operating mode	OFF / Numerical synchronization / Waveform synchronization Numerical synchronization cannot be selected when the data update rate is 10 ms. Waveform synchronization operates only when master device has more than 3 channels
Synchronized items	Numerical synchronization mode Data update timing, start/stop/data reset Waveform synchronization mode Voltage/current sampling timing
Synchronization delay	Numerical synchronization mode Max. 20 $\mu$ s Waveform synchronization mode Up to 5 samples
Transfer items	Numerical synchronization mode Basic measurement parameters for up to six channels (including motor data) Waveform synchronization mode Voltage/current sampling waveforms for up to three channels (not including motor data). However, the maximum number of channels is limited to a total of six, including the master instrument's channels.

## General Specifications

Operating environment	Indoors at an elevation of up to 2000 m in a Pollution Level 2 environment
Storage temperature and humidity	-10°C to 50°C, 80% RH or less (no condensation)
Operating temperature and humidity	0°C to 40°C, 80% RH or less (no condensation)
Dielectric strength	50 Hz/60 Hz 5.4 kV rms AC for 1 min. (sensed current of 1 mA) Between voltage input terminals and instrument enclosure, and between current sensor input terminals and interfaces 1 kV rms AC for 1 min. (sensed current of 3 mA) Between motor input terminals (Ch. A, Ch. B, Ch. C, and Ch. D) and the instrument enclosure
Standards	Safety EN61010 EMC EN61326 Class A
Rated supply voltage	100 V AC to 240 V AC, 50 Hz/60 Hz
Maximum rated power	200 VA
External dimensions	Approx. 430 mm (16.93 in)W x 177 mm (6.97 in)H x 450 mm (17.72 in)D (excluding protruding parts)
Mass	Approx. 14 kg (49.4 oz) (PW6001-16)
Backup battery life	Approx. 10 years (reference value at 23°C) (lithium battery that stores time and setting conditions)
Product warranty period	3 year
Guaranteed accuracy period	6 months (1-year accuracy = 6-month accuracy x 1.5)
Post-adjustment accuracy guaranteed period	6 months
Accuracy guarantee conditions	Accuracy guarantee temperature and humidity range: 23°C $\pm$ 3°C, 80% RH or less Warm-up time: 30 min. or more
Accessories	Instruction manual x 1, power cord x 1, D-sub 25-pin connector x 1 (PW6001-1x only)

## Other functions

Clock function	Auto-calendar, automatic leap year detection, 24-hour clock
Actual time accuracy	When the instrument is on, $\pm$ 100 ppm; when the instrument is off, within $\pm$ 3 sec./day (25°C)
Sensor identification	Current sensors connected to Probe1 are automatically detected.
Zero-adjustment function	After the AC/DC current sensor's DEMAG signal is sent, zero-correction of the voltage and current input offsets is performed.
Touch screen correction	Position calibration is performed for the touch screen.
Key lock	While the key lock is engaged, the key lock icon is displayed on the screen.

Current sensors

\*Scan the QR codes on the right to download technical briefs about current measurements.



# High-accuracy sensors: direct connection type (connect to Probe1 input terminal)

The newly developed DCCT method provides world-leading measurement bands and accuracy at a 50 A rating. Delivering a direct-coupled type current testing tool that brings out the PW6001 POWER ANALYZER's maximum potential. (A 5 A-rated version is also available. Contact us for more information.)

	AC/DC CURRENT BOX PW9100-03	AC/DC CURRENT BOX PW9100-04
External Appearance		
Number of input channels	3ch	4 ch
Rated primary current	50 A AC/DC	
Frequency band	DC to 3.5 MHz (-3 dB)	
Measurement terminals	Terminal block (with safety cover), M6 screws	
Basic accuracy	±0.02% rdg. ±0.005% f.s. (amplitude), ±0.1° (phase) (At 45 ≤ f ≤ 65 Hz)	
Frequency response (Amplitude)	±0.02% rdg. ±0.007% f.s. (amplitude), (At DC) to 45 Hz: ±0.1% rdg. ±0.02% f.s. to 1 kHz: ±0.1% rdg. ±0.01% f.s. to 50 kHz: ±1% rdg. ±0.02% f.s. to 100 kHz: ±2% rdg. ±0.05% f.s. to 1 MHz: ±10% rdg. ±0.05% f.s. 3.5 MHz: -3 dB Typical	
Input resistance	1.5 mΩ or less (50 Hz/60 Hz)	
Operating temperature range	Temperature: 0°C to 40°C (32°F to 104°F), Humidity: 80% R.H. or less (no condensation)	
Effects of common-mode voltage (CMRR)	50 Hz/60 Hz: 120 dB or greater, 100 kHz: 120 dB or greater (Effect on output voltage/common-mode voltage)	
Maximum voltage to ground	1000 V (measurement category II), 600 V (measurement category III), anticipated transient overvoltage: 6000 V	
Dimensions	430 mm (16.93 in) W x 88 mm (3.46 in) H x 260 mm (10.24 in) D, Cable length: 0.8 m (2.62 ft)	
Mass	3.7 kg (130.5 oz)	4.3 kg (151.7 oz)
Derating Characteristics		

## Wiring connection example 1 – Existing direct-input connection method

For more reliable wideband high-accuracy measurements. Use as an alternative to existing direct-input power meters. Use two PW9100-03 devices (the 3 ch models) for 6-channel measurements.

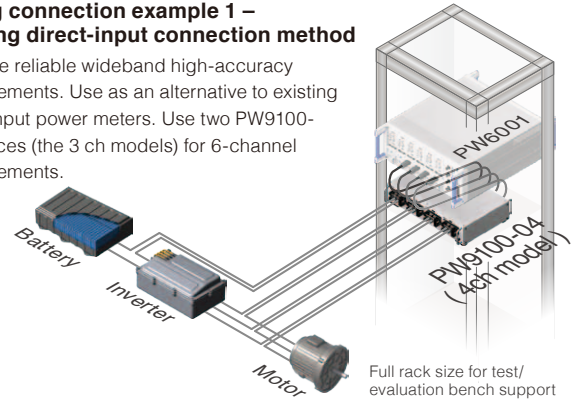

## Wiring connection example 2 – Introducing a new and innovative measuring method

Shorten the wiring for current measurement by installing the PW9100 close to the measurement target. This will also keep the effects of wiring resistance, capacity coupling and other objective factors on the measured values to a minimum.

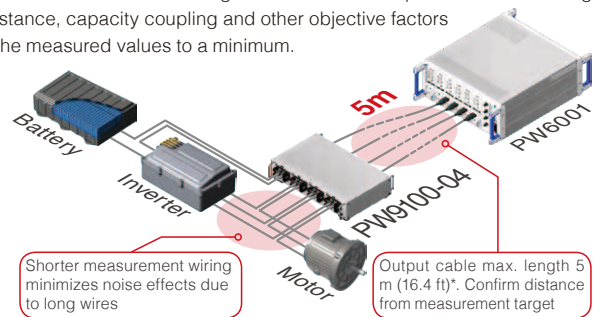

\*Requires CT9902 EXTENSION CABLE

All new current sensor

# High-accuracy sensors: pull-through type (connect to Probe1 input terminal)

	AC/DC CURRENT SENSOR CT6904
External Appearance	 <b>NEW</b> Wideband 4 MHz
Rated primary current	AC/DC 500 A rms
Frequency band	DC to 4 MHz
Diameter of measurable conductors	φ 32 mm (1.26 in) or less
Basic accuracy	For 45 Hz to 65 Hz Amplitude: ±0.02% rdg. ±0.007% f.s. Phase: ±0.05° For DC Amplitude: ±0.025% rdg. ±0.007% f.s.
Frequency characteristics (Amplitude)	to 16 Hz: ±0.2% rdg. ±0.02% f.s. 65 Hz to 850 Hz: ±0.05% rdg. ±0.007% f.s. to 10 kHz: ±0.4% rdg. ±0.02% f.s. to 300 kHz: ±2.0% rdg. ±0.05% f.s. to 1 MHz: ±5.0% rdg. ±0.05% f.s. 4 MHz: ±3dB Typical
Operating temperature range	-10°C to 50°C (14°F to 122°F)
Effect of conductor position	±0.01% rdg. or less (100 A input, 50/60 Hz)
Effects of external magnetic fields	In 400 A/m magnetic field (DC and 60 Hz) 50 mA or less
Maximum rated voltage to ground	CAT III 1000 V
Output connector	HIOKI ME15W
Dimensions	139 mm (5.47 in) W x 120 mm (4.72 in) H x 52 mm (2.05 in) D, Cable length: 3 m (9.84 ft)
Mass	Approx. 1.0 kg (35.3 oz)
Derating Characteristics	

The CT6904 delivers a measurement band that is 40x greater than the previous model along with high accuracy and a 500 A rating, making it a world-class current sensor that provides the ultimate level of performance when used in conjunction with the Power Analyzer PW6001. (The sensor is also available in an 800 A rated version. Please contact Hioki for details.)

## 4 MHz Measurement Range, 40x Conventional Models

Newly developed opposed split coil technology is used in winding (CT) areas, achieving a wide measurement range from DC to 4 MHz.

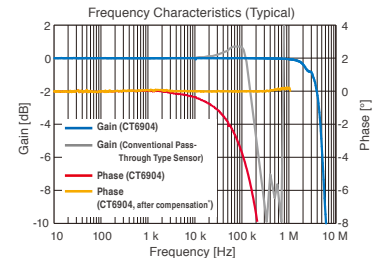
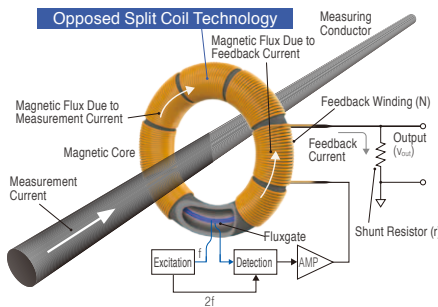

\* When performing phase compensation with HIOKI POWER ANALYZER PW6001

## High Noise Resistance Common-Mode Rejection Ratio (CMRR) of 120 dB or More (100 kHz)

Completely shielding the sensor's opposed split coil with a solid shield featuring a proprietary shape lets the sensor deliver high accuracy measurement that is not affected by nearby voltages.

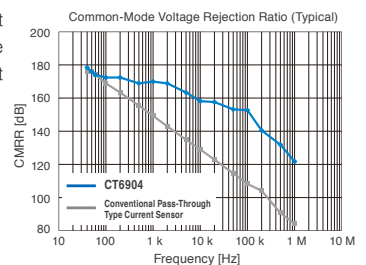

## High-accuracy sensors: pull-through type (connect to Probe1 input terminal)

Model	AC/DC CURRENT SENSOR CT6862-05	AC/DC CURRENT SENSOR CT6863-05	AC/DC CURRENT SENSOR 9709-05	AC/DC CURRENT SENSOR CT6865-05
Appearance				
Rated primary current	50 A AC/DC	200 A AC/DC	500 A AC/DC	1000 A AC/DC
Frequency band	DC to 1 MHz	DC to 500 kHz	DC to 100 kHz	DC to 20 kHz
Diameter of measurable conductors	Max.φ 24mm (0.94")	Max.φ 24 mm (0.94")	Max.φ 36 mm (1.42")	Max.φ 36 mm (1.42")
Basic accuracy	±0.05 % rdg.±0.01 % f.s. (amplitude) ±0.2° (phase, not defined for DC) (At DC and 16 Hz to 400 Hz)	±0.05 % rdg.±0.01 % f.s. (amplitude) ±0.2° (phase, not defined for DC) (At DC and 16 Hz to 400 Hz)	±0.05 % rdg.±0.01 % f.s. (amplitude) ±0.2° (phase, not defined for DC) (At DC and 45 Hz to 66 Hz)	±0.05 % rdg.±0.01 % f.s. (amplitude) ±0.2° (phase, not defined for DC) (At DC and 16 Hz to 66 Hz)
Frequency characteristics (Amplitude)	to 16 Hz: ±0.1% rdg. ±0.02% f.s. 400Hz to 1kHz: ±0.2% rdg. ±0.02% f.s. to 50 kHz: ±1.0% rdg. ±0.02% f.s. to 100 kHz: ±2.0% rdg. ±0.05% f.s. to 1 MHz: ±30% rdg. ±0.05% f.s.	to 16 Hz: ±0.1% rdg. ±0.02% f.s. 400Hz to 1kHz: ±0.2% rdg. ±0.02% f.s. to 10 kHz: ±1.0% rdg. ±0.02% f.s. to 100 kHz: ±5.0% rdg. ±0.05% f.s. to 500 kHz: ±30% rdg. ±0.05% f.s.	to 45 Hz: ±0.2% rdg. ±0.02% f.s. 66 Hz to 500 Hz: ±0.2% rdg. ±0.02% f.s. to 5 kHz: ±0.5% rdg. ±0.05% f.s. to 10 kHz: ±2.0% rdg. ±0.10% f.s. to 100 kHz: ±30% rdg. ±0.10% f.s.	to 16 Hz: ±0.1% rdg. ±0.02% f.s. 66 Hz to 100 Hz: ±0.5% rdg. ±0.02% f.s. to 500 Hz: ±1.0% rdg. ±0.02% f.s. to 5 kHz: ±5.0% rdg. ±0.05% f.s. to 20 kHz: ±30% rdg. ±0.1% f.s.
Operating Temperature	-30°C to 85°C (-22°F to 185°F)	-30°C to 85°C (-22°F to 185°F)	0°C to 50°C (32°F to 122°F)	-30°C to 85°C (-22°F to 185°F)
Effect of conductor position	Within ±0.01% rdg. (50 A, DC to 100 Hz)	Within ±0.01% rdg. (100 A, DC to 100 Hz)	Within ±0.05% rdg. (DC 100 A)	Within ±0.05% rdg. (1000 A, 50/60 Hz)
Effect of external magnetic fields	10 mA equivalent or lower (400 A/m, 60 Hz and DC)	50 mA equivalent or lower (400 A/m, 60 Hz and DC)	50 mA equivalent or lower (400 A/m, 60 Hz and DC)	200 mA equivalent or lower (400 A/m, 60 Hz and DC)
Maximum rated voltage to earth	CAT III 1000 V rms	CAT III 1000 V rms	CAT III 1000 V rms	CAT III 1000 V rms
Dimensions	70W (2.76") × 100H (3.94") × 53D (2.09") mm Cable length: 3 m (9.84 ft)	70W (2.76") × 100H (3.94") × 53D (2.09") mm Cable length: 3 m (9.84 ft)	160W (6.30") × 112H (4.41") × 50D (1.97") mm Cable length: 3 m (9.84 ft)	160W (6.30") × 112H (4.41") × 50D (1.97") mm Cable length: 3 m (9.84 ft)
Mass	340 g (12.0 oz.)	350 g (12.3 oz.)	850 g (30.0 oz.)	980 g (35.3 oz.)
Derating properties				





Custom cable lengths also available. Please inquire with your Hioki distributor.



## High-accuracy sensors: clamp type (connect to Probe1 input terminal)

Model	AC/DC CURRENT PROBE CT6841-05	AC/DC CURRENT PROBE CT6843-05	AC/DC CURRENT PROBE CT6844-05	AC/DC CURRENT PROBE CT6845-05	AC/DC CURRENT PROBE CT6846-05
Appearance					
Rated primary current	20 A AC/DC	200 A AC/DC	500 A AC/DC	500 A AC/DC	1,000 A AC/DC
Frequency band	DC to 1 MHz	DC to 500 kHz	DC to 200 kHz	DC to 100 kHz	DC to 20 kHz
Diameter of measurable conductors	Max.φ 20 mm (0.79") (insulated conductor)	Max.φ 20 mm (0.79") (insulated conductor)	Max.φ 20 mm (0.79") (insulated conductor)	Max.φ 50 mm (1.97") (insulated conductor)	Max.φ 50 mm (1.97") (insulated conductor)
Basic accuracy	±0.3% rdg. ±0.01% f.s. (amplitude) ±0.1° (phase) (At DC < f ≤ 100 Hz) ±0.3% rdg. ±0.05% f.s. (amplitude) (At DC)	±0.3% rdg. ±0.01% f.s. (amplitude) ±0.1° (phase) (At DC < f ≤ 100 Hz) ±0.3% rdg. ±0.02% f.s. (amplitude) (At DC)	±0.3% rdg. ±0.01% f.s. (amplitude) ±0.1° (phase) (At DC < f ≤ 100 Hz) ±0.3% rdg. ±0.02% f.s. (amplitude) (At DC)	±0.3% rdg. ±0.01% f.s. (amplitude) ±0.1° (phase) (At DC < f ≤ 100 Hz) ±0.3% rdg. ±0.02% f.s. (amplitude) (At DC)	±0.3% rdg. ±0.01% f.s. (amplitude) ±0.1° (phase) (At DC < f ≤ 100 Hz) ±0.3% rdg. ±0.02% f.s. (amplitude) (At DC)
Frequency characteristics (Amplitude)	to 500 Hz: ±0.3% rdg. ±0.02% f.s. to 1 kHz: ±0.5% rdg. ±0.02% f.s. to 10 kHz: ±1.5% rdg. ±0.02% f.s. to 100 kHz: ±5.0% rdg. ±0.05% f.s. to 1 MHz: ±30% rdg. ±0.05% f.s.	to 500 Hz: ±0.3% rdg. ±0.02% f.s. to 1 kHz: ±0.5% rdg. ±0.02% f.s. to 10 kHz: ±1.5% rdg. ±0.02% f.s. to 50 kHz: ±5.0% rdg. ±0.02% f.s. to 500 kHz: ±30% rdg. ±0.05% f.s.	to 500 Hz: ±0.3% rdg. ±0.02% f.s. to 1 kHz: ±0.5% rdg. ±0.02% f.s. to 10 kHz: ±1.5% rdg. ±0.02% f.s. to 50 kHz: ±5.0% rdg. ±0.02% f.s. to 200 kHz: ±30% rdg. ±0.05% f.s.	to 500 Hz: ±0.3% rdg. ±0.02% f.s. to 1 kHz: ±0.5% rdg. ±0.02% f.s. to 10 kHz: ±1.5% rdg. ±0.02% f.s. to 20 kHz: ±5.0% rdg. ±0.02% f.s. to 100 kHz: ±30% rdg. ±0.05% f.s.	to 500 Hz: ±0.5% rdg. ±0.02% f.s. to 1 kHz: ±1.0% rdg. ±0.02% f.s. to 5 kHz: ±2.0% rdg. ±0.02% f.s. to 10 kHz: ±5.0% rdg. ±0.05% f.s. to 20 kHz: ±30% rdg. ±0.10% f.s.
Operating Temperature	-40°C to 85°C (-40°F to 185°F)	-40°C to 85°C (-40°F to 185°F)	-40°C to 85°C (-40°F to 185°F)	-40°C to 85°C (-40°F to 185°F)	-40°C to 85°C (-40°F to 185°F)
Effect of conductor position	Within ±0.1% rdg. (At 20 A, DC to 100 Hz input)	Within ±0.1% rdg. (At 100 A, DC to 100 Hz input)	Within ±0.1% rdg. (At 100 A, DC to 100 Hz input)	Within ±0.2% rdg. (At 100 A, DC to 100 Hz input)	Within ±0.2% rdg. (At 1000A, 50/60 Hz input)
Effect of external magnetic fields	50 mA equivalent or lower (400 A/m, 60 Hz and DC)	50 mA equivalent or lower (400 A/m, 60 Hz and DC)	100 mA equivalent or lower (400 A/m, 60 Hz and DC)	150 mA equivalent or lower (400 A/m, 60 Hz and DC)	150 mA equivalent or lower (400 A/m, 60 Hz and DC)
Dimensions	153W (6.02") × 67H (2.64") × 25D (0.98") mm Cable length: 3 m (9.84 ft)	153W (6.02") × 67H (2.64") × 25D (0.98") mm Cable length: 3 m (9.84 ft)	153 (6.02") W × 67 (2.64") H × 25 (0.98") D mm Cable length: 3 m (9.84 ft)	238 (9.37") W × 116 (4.57") H × 35 (1.38") D mm Cable length: 3 m (9.84 ft)	238 (9.37") W × 116 (4.57") H × 35 (1.38") D mm Cable length: 3 m (9.84 ft)
Mass	350 g (12.3 oz.)	370 g (13.1 oz.)	400 g (14.1 oz.)	860 g (30.3 oz.)	990 g (34.9 oz.)
Derating properties					

Custom cable lengths also available. Please inquire with your Hioki distributor.

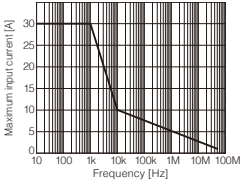
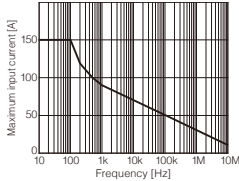
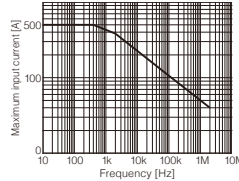
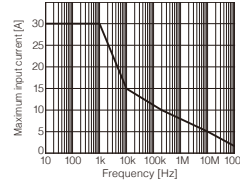
# Wide-band probes (connect to Probe2 input terminal)

Model	CLAMP ON PROBE 3273-50	CLAMP ON PROBE 3274	CLAMP ON PROBE 3275	CLAMP ON PROBE 3276
Appearance				
Rated primary current	30 A AC/DC	150 A AC/DC	500 A AC/DC	30 A AC/DC
Frequency band	DC to 50 MHz (-3 dB)	DC to 10 MHz (-3 dB)	DC to 2 MHz (-3 dB)	DC to 100 MHz (-3 dB)
Diameter of measurable conductors	Max.φ 5 mm (0.20") (insulated conductors)	Max.φ 20 mm (0.79") (insulated conductors)	Max.φ 20 mm (0.79") (insulated conductors)	Max.φ 5 mm (0.20") (insulated conductors)
Basic accuracy	0 to 30 A rms ±1.0% rdg. ±1 mV 30 A rms to 50 A peak ±2.0% rdg. (At DC and 45 to 66 Hz)	0 to 150 A rms ±1.0% rdg. ±1 mV 150 A rms to 300 A peak ±2.0% rdg. (At DC and 45 to 66 Hz)	0 to 500 A rms ±1.0% rdg. ±5 mV 500 A rms to 700 A peak ±2.0% rdg. (At DC and 45 to 66 Hz)	0 to 30 A rms ±1.0% rdg. ±1 mV 30 A rms to 50 A peak ±2.0% rdg. (At DC and 45 to 66 Hz)
Operating temperature	0°C to 40°C (32°F to 104°F)	0°C to 40°C (32°F to 104°F)	0°C to 40°C (32°F to 104°F)	0°C to 40°C (32°F to 104°F)
Effect of external magnetic fields	20 mA equivalent or lower (400 A/m, 60 Hz and DC)	150 mA equivalent or lower (400 A/m, 60 Hz and DC)	400 mA equivalent or lower (400 A/m, 60 Hz and DC)	400 mA equivalent or lower (400 A/m, 60 Hz and DC)
Dimensions	175W (6.89") x 18H(0.71") x 40D (1.57") mm Cable length: 1.5 m	176W (6.93") x 69H (2.72") x 27D(1.06") mm Cable length: 2 m	176W (6.93") x 69H (2.72") x 27D(1.06") mm Cable length: 2 m	175W (6.89") x 18H(0.71") x 40D (1.57") mm Cable length: 1.5 m
Mass	230 g (8.1 oz)	500 g (17.6 oz)	520 g (18.3 oz)	240 g (8.5 oz)
Derating properties				

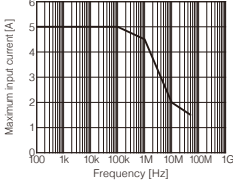
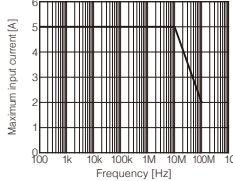
Model	CURRENT PROBE CT6700	CURRENT PROBE CT6701
Appearance		
Rated primary current	5 Arms AC/DC	5 Arms AC/DC
Frequency band	DC to 50 MHz (-3 dB)	DC to 120 MHz (-3 dB)
Diameter of measurable conductors	Max.φ 5 mm (0.20") (insulated conductors)	Max.φ 5 mm (0.20") (insulated conductors)
Basic accuracy	typical ±1.0% rdg. ±1 mV ±3.0% rdg. ±1 mV (At DC and 45 to 66 Hz)	typical ±1.0% rdg. ±1 mV ±3.0% rdg. ±1 mV (At DC and 45 to 66 Hz)
Operating temperature	0°C to 40°C (32°F to 104°F)	0°C to 40°C (32°F to 104°F)
Effects of external magnetic fields	20 mA equivalent or lower (400 A/m, 60 Hz and DC)	5 mA equivalent or lower (400 A/m, 60 Hz and DC)
Dimensions	155W (6.10") x 18H(0.71") x 26D (1.02") mm Cable length: 1.5 m	155W (6.10") x 18H(0.71") x 26D (1.02") mm Cable length: 1.5 m
Mass	250 g (8.8 oz)	250 g (8.8 oz)
Derating properties		

## Sensor switching method

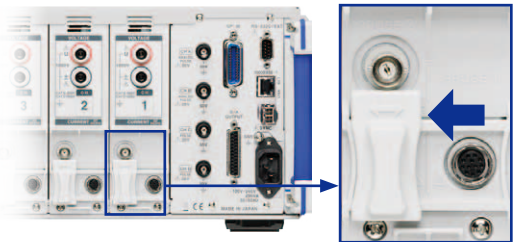

High accuracy sensor terminal: Slide the cover to the left.

When connecting  
CT6862-05, CT6863-05, 9709-05, CT6904, CT6865-05,  
CT6841-05, CT6843-05, CT6844-05, CT6845-05,  
CT6846-05, PW9100-03, PW9100-04

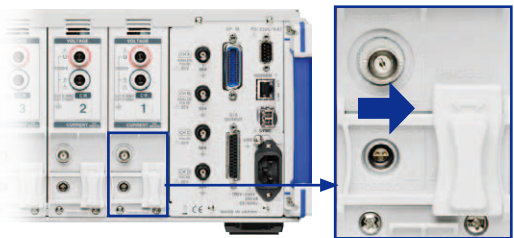

Wideband probe terminal: Slide the cover to the right.

When connecting  
3273-50, 3274, 3275, 3276, CT6700 or CT6701

**Model: POWER ANALYZER PW6001**

Model No. (Order Code)	Number of built-in channels	Motor Analysis & D/A Output
PW6001-01	1ch	—
PW6001-02	2ch	—
PW6001-03	3ch	—
PW6001-04	4ch	—
PW6001-05	5ch	—
PW6001-06	6ch	—
PW6001-11	1ch	✓
PW6001-12	2ch	✓
PW6001-13	3ch	✓
PW6001-14	4ch	✓
PW6001-15	5ch	✓
PW6001-16	6ch	✓



PW6001-16 (with 6 channels and Motor Analysis & D/A Output)

Accessories: Instruction manual x 1, power cord x 1, D-sub 25-pin connector (PW6001-11 to -16 only) x 1

- The optional voltage cord and current sensor are required for taking measurements.
- Specify the number of built-in channels and inclusion of Motor Analysis & D/A Output upon order for factory installation. These options cannot be changed or added at a later date.

**Current measurement options**

Model	Model No. (Order Code)	Note
AC/DC CURRENT SENSOR	CT6862-05	(50A)
AC/DC CURRENT SENSOR	CT6863-05	(200A)
AC/DC CURRENT SENSOR	CT6904	(500A)
AC/DC CURRENT SENSOR	9709-05	(500A)
AC/DC CURRENT SENSOR	CT6865-05	(1000A)
AC/DC CURRENT PROBE	CT6841-05	(20A)
AC/DC CURRENT PROBE	CT6843-05	(200A)
AC/DC CURRENT PROBE	CT6844-05	(500 A, φ20 mm)
AC/DC CURRENT PROBE	CT6845-05	(500 A, φ50 mm)
AC/DC CURRENT PROBE	CT6846-05	(1000 A)
AC/DC CURRENT BOX	PW9100-03	(50 A, 3 ch)
AC/DC CURRENT BOX	PW9100-04	(50 A, 4 ch)
CLAMP ON PROBE	3273-50	(30A)
CLAMP ON PROBE	3274	(150A)

Model	Model No. (Order Code)	Note
CLAMP ON PROBE	3275	(500A)
CLAMP ON PROBE	3276	(30A)
CURRENT PROBE	CT6700	(5A)
CURRENT PROBE	CT6701	(5A)

**CONVERSION CABLE CT9900**  
 HIOKI PL23 (10 pin) to HIOKI ME15W (12 pin) connector  
 For use with CT6862, CT6863, 9709, CT6865, CT6841, CT6843.  
 When using a sensor without "-05" in the model name, Conversion Cable CT9900 must be used to make the connection.

**SENSOR UNIT CT9557**  
 Merges up to four current sensor output waveforms on a single channel, for output to PW6001.

**CONNECTION CABLE CT9904**  
 1 m cable; required to connect the PW6001 to the CT9557's addition waveform output terminal.

**Voltage measurement options**



CATIV 600V, CATIII 1000V

**VOLTAGE CORD L9438-50**  
 1000 V specifications, Black/Red, 3 m (9.84 ft) length, Alligator clip x2



CATIV 600V, CATIII 1000V

**VOLTAGE CORD L1000**  
 1000 V specifications, Red/Yellow/Blue/Gray each 1, Black 4, Alligator clip x8, 3m (9.84ft) length



CATIV 600V, CATIII 1000V

**CONNECTION CORD L9257**  
 1000 V specifications, red/black x 1 ea., 1.2 m length



**GRABBER CLIP 9243**  
 Attaches to the tip of the banana plug cable, Red/Black: 1 each, 196 mm (7.72 in) length, CAT III 1000 V



CATIV 600V, CATIII 1000V

**PATCH CORD**  
 Banana branch to banana clip, for branching voltage input, 0.5 m length

**Connection options**



**CONNECTION CORD L9217**  
 For motor signal input, cord has insulated BNC connectors at both ends, 1.6 m (5.25 ft) length



**LAN CABLE 9642**  
 Straight Ethernet cable, supplied with straight to cross conversion adapter, 5 m (16.41 ft) length



**RS-232C CABLE 9637**  
 For the PC, 9 pins - 9 pins, cross, 1.8m (5.91 ft) length



**GP-IB CONNECTOR CABLE 9151-02**  
 2m (6.56 ft) length



**CONNECTION CABLE 9444**  
 For external control interface, 9 pin - 9 pin straight, 1.5 m (4.92 ft) length



**OPTICAL CONNECTION CABLE L6000**  
 For synchronized control, 50/125 μm wavelength multimode fiber, 10 m (32.81 ft) length

**Other**

The following made-to-order items are also available. Please contact your Hioki distributor or subsidiary for more information.

- Carrying case (hard trunk, with casters)
- D/A output cable, D-sub 25-pin-BNC (male), 20 ch conversion, 2.5 m (8.20 ft) length
- Bluetooth® serial converter adapter cable 1 m (3.28 ft)
- Rackmount fittings (EIA, JIS)
- Optical connection cable, Max. 500 m (1640.55 ft) length
- PW9100 5 A rated version, CT6904 800 A rated version
- 2000A pull-through type sensor (DC to 5 kHz, φ80 mm)

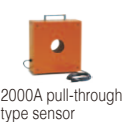

Note: Company names and Product names appearing in this catalog are trademarks or registered trademarks of various companies.



**HIOKI E. E. CORPORATION**

**HEADQUARTERS**  
 81 Koizumi, Ueda, Nagano 386-1192 Japan  
 TEL +81-268-28-0562 FAX +81-268-28-0568  
 http://www.hioki.com / E-mail: os-com@hioki.co.jp

**HIOKI USA CORPORATION**  
 TEL +1-609-409-9109 FAX +1-609-409-9108  
 http://www.hiokiusa.com / E-mail: hioki@hiokiusa.com

**HIOKI (Shanghai) SALES & TRADING CO., LTD.**  
 TEL +86-21-6391-0090/0092 FAX +86-21-6391-0360  
 http://www.hioki.cn / E-mail: info@hioki.com.cn

**HIOKI SINGAPORE PTE. LTD.**  
 TEL +65-6634-7677 FAX +65-6634-7477  
 E-mail: info-sg@hioki.com.sg

**HIOKI KOREA CO., LTD.**  
 TEL +82-2-2183-8847 FAX +82-2-2183-3360  
 E-mail: info-kr@hioki.co.jp

**HIOKI EUROPE GmbH**  
 TEL +49-6173-3234063 FAX +49-6173-3234064  
 E-mail: hioki@hioki.eu

DISTRIBUTED BY